

SSG5080A Series Signal Generator

Programming Guide

PG0805A-E01A



Contents

1	Programming Overview	5
1.1	Build Communication	5
1.1.1	<i>Build Communication Using VISA</i>	<i>5</i>
1.1.2	<i>Build Communication Using Sockets</i>	<i>9</i>
1.1.3	<i>Connecting the signal generator via the USB Host port</i>	<i>9</i>
1.2	Remote Control Capabilities	10
1.2.1	<i>User-defined Programming</i>	<i>10</i>
1.2.2	<i>Send SCPI Commands via NI-MAX</i>	<i>10</i>
2	SCPI Overview	14
2.1	Command Format	14
2.2	Symbol Instruction	14
2.3	Parameter Type	15
2.4	Command Abbreviation	17
3	SCPI Commands.....	18
3.1	IEEE Common Commands	18
3.1.1	<i>Identification Query (*IDN)</i>	<i>18</i>
3.1.2	<i>Reset (*RST)</i>	<i>18</i>
3.1.3	<i>Clear Status (*CLS)</i>	<i>19</i>
3.1.4	<i>Standard Event Status Enable (*ESE)</i>	<i>19</i>
3.1.5	<i>Standard Event Status Register Query (*ESR).....</i>	<i>19</i>
3.1.6	<i>Operation Complete Query (*OPC).....</i>	<i>20</i>
3.1.7	<i>Service Request Enable (*SRE).....</i>	<i>20</i>
3.1.8	<i>Status Byte Query (*STB)</i>	<i>20</i>
3.1.9	<i>Wait-to-Continue (*WAI)</i>	<i>21</i>
3.1.10	<i>Self Test Query (*TST)</i>	<i>21</i>
3.2	System Subsystem.....	21
3.2.1	<i>System Time (:SYSTem:TIME)</i>	<i>21</i>

3.2.2	System Date (:SYSTem:DATE)	22
3.2.3	IP Address (:SYSTem:COMMunicate:LAN:IPADdress)	22
3.2.4	Gateway (:SYSTem:COMMunicate:LAN:GATeway)	23
3.2.5	Subnet Mask (:SYSTem:COMMunicate:LAN:SMASk)	23
3.2.6	IP Config (:SYSTem:COMMunicate:LAN:TYPE)	24
3.2.7	Language (SYSTem:LANGUage)	24
3.2.8	Screen Saver (SYSTem:SCReen:SAVer)	25
3.2.9	Beeper (SYSTem:ALARm)	25
3.2.10	Setup Type (:SYSTem:PON:TYPE)	26
3.2.11	Power On Line (SYSTem:POWeron:TYPE).....	26
3.2.12	10M Adjustment State (:SYSTem:REF:DAC:STAT).....	27
3.2.13	Ref Osc Code (:SYSTem:REF:DAC)	27
3.2.14	Ref Osc Code Store (:SYSTem:REF:DAC:SAVE)	28
3.2.15	Ref Osc Code Load (:SYSTem:REF:DAC:LOAD)	28
3.2.16	Reset Ref Osc Code to Default (:SYSTem:REF:DAC:DEFault)	28
3.2.17	GPIB Address (SYSTem:GPIB).....	29
3.3	Preset Subsystem	29
3.3.1	Preset (:SOURce:PRESet).....	29
3.3.2	System Preset (:SYSTem:PRESet).....	30
3.3.3	Preset Save (:SYSTem:PRESet:SAVE)	30
3.3.4	Preset Path (:SYSTem:PRESet:PATH)	31
3.3.5	Preset Type (:SYSTem:PRESet:TYPE)	31
3.3.6	Factory Reset (:SYSTem:FDEFault)	32
3.3.7	Reset & Clear (SYSTem:RESet:CLEar).....	32
3.4	Output Subsystem.....	33
3.4.1	RF Output (:OUTPut[:STATe])	33
3.4.2	RF Output ([:SOURce]:OUTPut)	33
3.5	Source Subsystem	34
3.5.1	[:SOURce]:FREQUency Subsystem.....	34

3.5.2	<i>[:SOURce]:POWer Subsystem</i>	36
3.5.3	<i>[:SOURce]:SWEep Subsystem</i>	49
3.5.4	<i>[:SOURce]:MODulation Subsystem</i>	63
3.5.5	<i>[:SOURce]:AM Subsystem</i>	64
3.5.6	<i>[:SOURce]:FM Subsystem</i>	67
3.5.7	<i>[:SOURce]:PM Subsystem</i>	73
3.5.8	<i>[:SOURce]:PULM Subsystem</i>	76
3.5.9	<i>[:SOURce]:LFOutput Subsystem</i>	89
3.5.10	<i>[:SOURce]:LFOutput:SWEep Subsystem</i>	92
3.6	Sense Subsystem	97
3.6.1	<i>Sensor Info (:SENSe[:POWer]:TYPE?)</i>	97
3.6.2	<i>Sensor State (:SENSe[:POWer]:STATus)</i>	98
3.6.3	<i>Measurement (:SENSe[:POWer]:VALue?)</i>	98
3.6.4	<i>Statistics State (:SENSe[:POWer]:STATISTICS:STATE)</i>	98
3.6.5	<i>Statistics Value (:READ[:POWer]?)</i>	99
3.6.6	<i>Statistics Max Value (:SENSe[:POWer]:STATISTICS:MAX?)</i>	99
3.6.7	<i>Statistics Min Value (:SENSe[:POWer]:STATISTICS:MIN?)</i>	100
3.6.8	<i>Statistics Mean Value (:SENSe[:POWer]:STATISTICS:AVG?)</i>	100
3.6.9	<i>Statistics Count (:SENSe[:POWer]:STATISTICS:COUNT?)</i>	100
3.6.10	<i>Statistics Clear (:SENSe[:POWer]:STATISTICS:CLEAR)</i>	101
3.6.11	<i>Auto Zero (:CALibration:ZERO:TYPE)</i>	101
3.6.12	<i>Zeroing (:SENSe[:POWer]:ZERO)</i>	102
3.6.13	<i>Frequency Type (:SENSe[:POWer]:SOURce)</i>	102
3.6.14	<i>Frequency (:SENSe[:POWer]:FREQuency)</i>	103
3.6.15	<i>Level Offset State (:SENSe[:POWer]:OFFSet:STATE)</i>	103
3.6.16	<i>Level Offset (:SENSe[:POWer]:OFFSet)</i>	104
3.6.17	<i>Average Type (:SENSe[:POWer]:FILTer:TYPE)</i>	104
3.6.18	<i>Average Times (:SENSe[:POWer]:FILTer:LENGth)</i>	105
3.6.19	<i>Internal Noise (:SENSe[:POWer]:FILTer:NSRatio)</i>	105

3.6.20	Logging (:SENSe[:POWer]:LOGGing:STATe).....	106
4	Programming Examples	107
4.1	VISA Examples.....	107
4.1.1	VC++ Example	107
4.1.2	VB Example	115
4.1.3	MATLAB Example.....	123
4.1.4	LabVIEW Example	126
4.2	Socket Examples	128
4.2.1	Python Example	128
4.2.2	Telnet Example	131

1 Programming Overview

The **SSG5080A** supports both USB and LAN interfaces. By using these interfaces, in combination with NI-VISA and programming languages, users can remotely control the signal generator. The instrument comes with an embedded web interface; VXI-11, Sockets and Telnet protocols can be used to communicate with the signal generator. This chapter introduces how to build communication between the signal generator and the PC. It also introduces the remote control capabilities.

1.1 Build Communication

1.1.1 Build Communication Using VISA

1. Install NI-VISA

Before programming, you will need to install NI-VISA, which you can download from the National Instruments VISA web site. There are full and Run-Time Engine versions of NI-VISA. The full version includes the NI device driver and a tool named NI MAX which is a user interface to control the device. The Run-Time Engine version is a smaller file than the full version only includes the NI device driver.

For example, you can get NI-VISA 18.0 full version from:

<http://www.ni.com/download/ni-visa-18.0/7597/en/>.

You can also download NI-VISA Run-Time Engine 18.0 to your PC and install it as default selection. Its installation process is similar with the full version.

After you downloaded the file you can follow the steps below to install it:

- a. Double click the NIVISA1800full.exe, dialog shown as below:

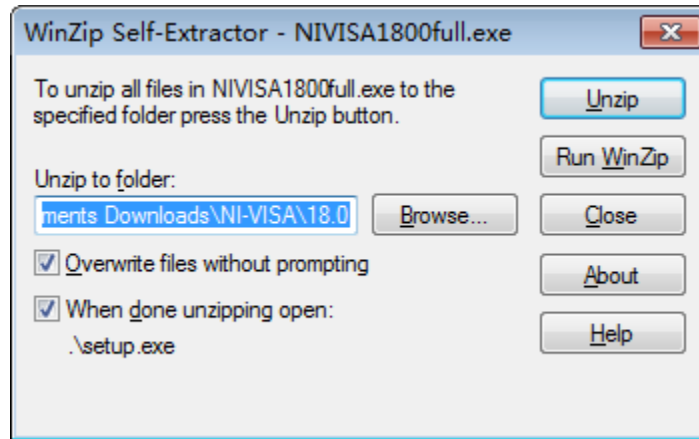

- b. Click Unzip, the installation process will automatically launch after unzipping files. If your computer needs to install .NET Framework 4.6.2, its setup process will auto start.

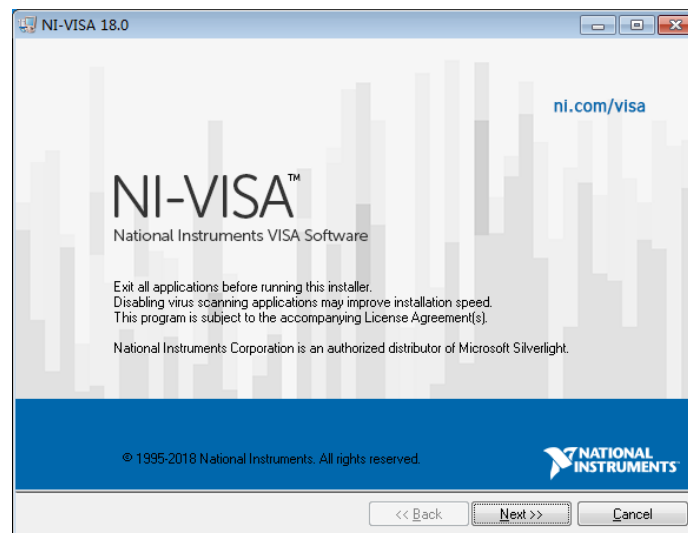

- c. The NI-VISA installing dialog is shown above. Click Next to start the installation process.

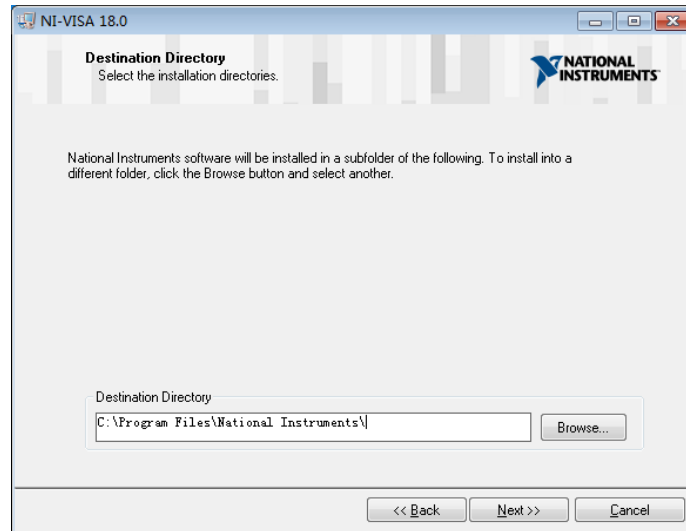

Set the install path, default path is “C:\Program Files\National Instruments\”, you can change it. Click Next, dialog shown as above.

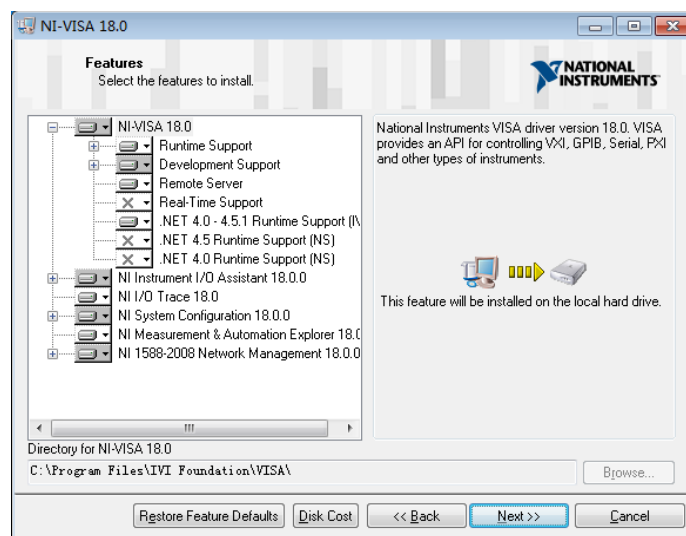

d. Click Next twice, in the License Agreement dialog, select the “I accept the above 2 License Agreement(s).”, and click Next, “Start Installation” dialog shown.

e. Click Next to run installation.

f.

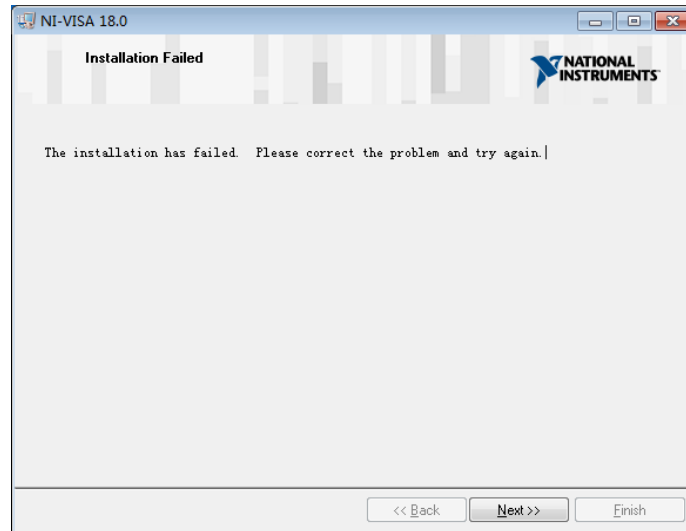

Now the installation is complete, reboot your PC.

2. Connect the Instrument

Depending on your specific model, your signal generator may be able to communicate with a PC through the USB or LAN interface. This manual uses the USB connection in the examples. (For instructions to communicate with a PC through the LAN interface see the User Manual.)

- a. Connect the USB Device interface at the rear panel of the signal generator and the USB Host interface of the PC using a USB cable. Assuming your PC is already turned on, turn on your signal generator and your PC will display the "Device Setup" screen as it automatically installs the device driver as shown below.

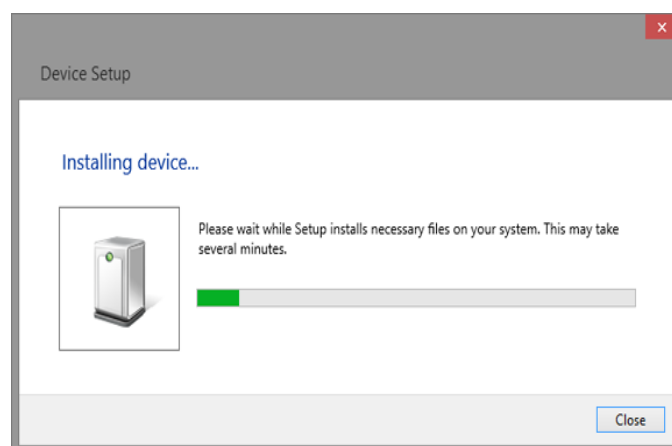

- b. Wait for the installation to complete and then proceed to the next step.

1.1.2 Build Communication Using Sockets

LAN communication using Sockets uses the Transmission Control Protocol/Internet Protocol (TCP/IP) layer that is included with many operating systems. A socket is a fundamental technology used for computer networking and allows applications to communicate using standard mechanisms built into network hardware and operating systems. The method accesses a port on the signal generator from which bidirectional communication with a network computer can be established. Unlike VISA, this technique uses currently available resources and doesn't require additional software/ hardware to run.

Before you can use sockets, you must select the signal generator socket port number to use:

- Standard mode. Available on port 5025. Use this port for simple programming.
- Telnet mode. The telnet SCPI service is available on port 5024.

1.1.3 Connecting the signal generator via the USB Host port

Refer to the following steps to finish the connection via USB:

1. Install NI-VISA on your PC for GPIB driver.
2. Connect the signal generator USB Host port to a PC's GPIB card port, with SIGLENT USB-GPIB adaptor.



3. Switch on the signal generator.
4. Press button on the front panel **System** → Interface → GPIB to enter the GPIB number.

The signal generator will be detected automatically as a new GPIB point.

1.2 Remote Control Capabilities

1.2.1 User-defined Programming

Users can use SCPI commands to program and control the signal generator. For details, refer to the introductions in “**Programming Examples**”.

1.2.2 Send SCPI Commands via NI-MAX

Users can control the signal generator remotely by sending SCPI commands via NI-MAX software.

1.2.2.1 Using USB

Run NI MAX software.

1. Click “Device and interface” at the upper left corner of the software.
2. Find the “USBTMC” device symbol.



3. Click “Open VISA Test Panel” option button, then the following interface will appear.
4. Click the “Input/Output” option button and click the “Query” option button in order to view the operation information.

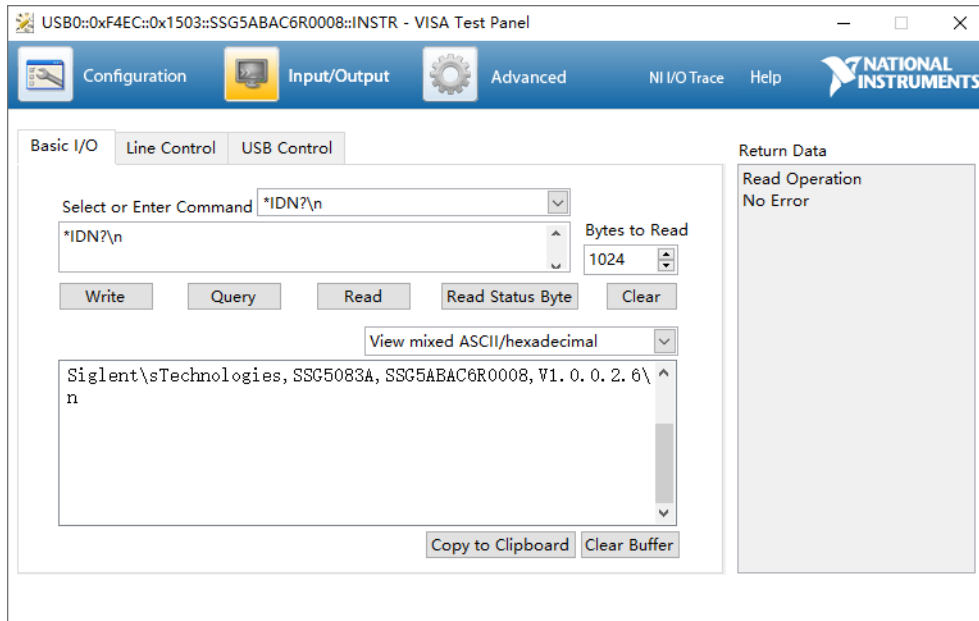

NOTE: The “*IDN?” command (known as the Identification Query) returns the instrument manufacturer, instrument model, serial number, and other identification information.

1.2.2.2 Using LAN

Add a Network Device, and select a VISA TCP/IP Resource as shown:

Run NI MAX software.

1. Click “Device and interface” at the upper left corner of the software
2. Find the “Network Devices” symbol, click “Add Network Devices”

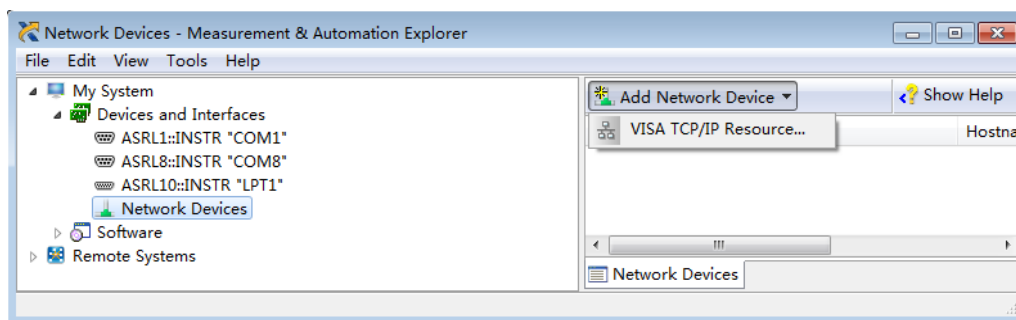

3. Select Manual Entry of LAN instrument, select Next, and enter the IP address as shown.

Click Finish to establish the connection:

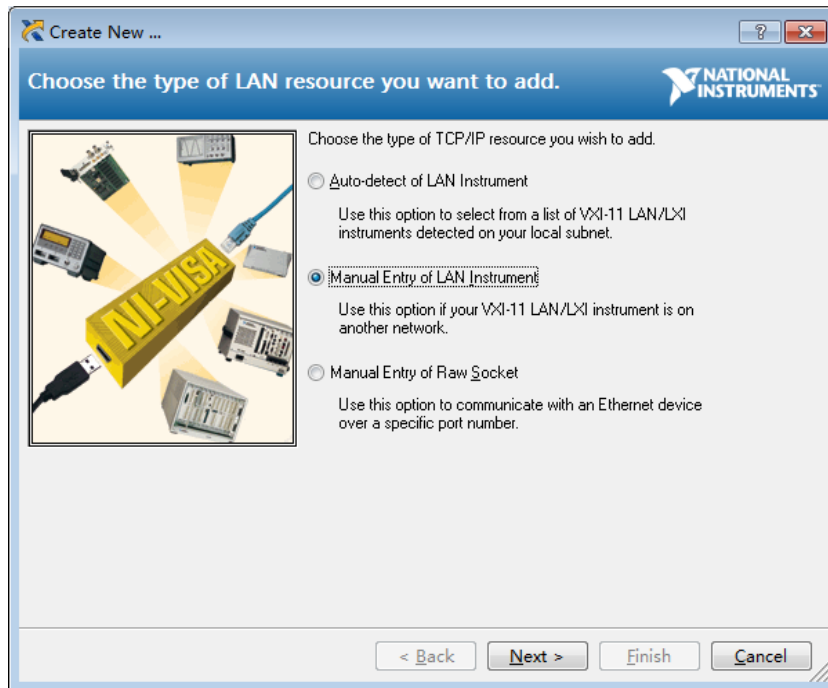

NOTE: Leave the LAN Device Name BLANK or the connection will fail.

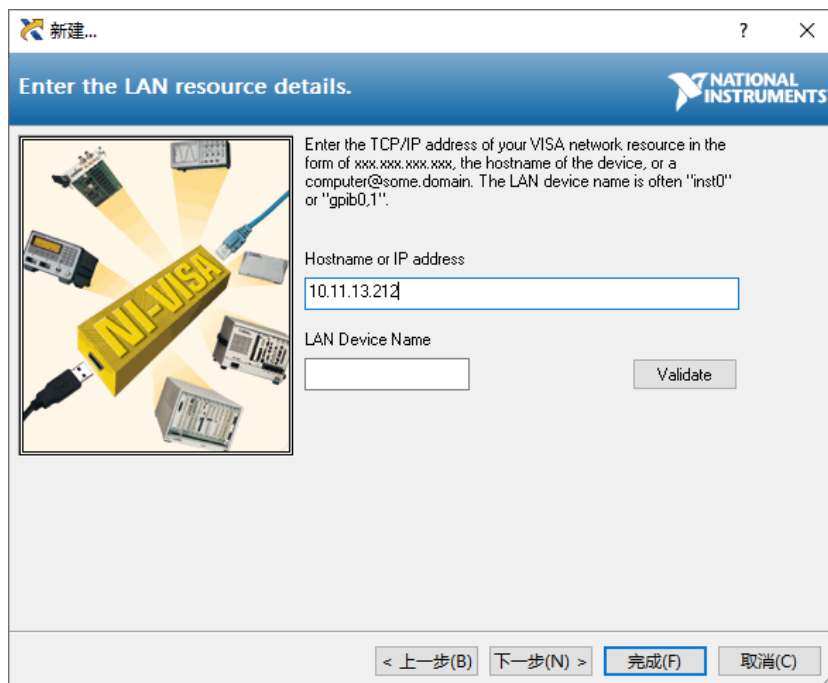

4. After a brief scan, the connection should be shown under Network Devices:

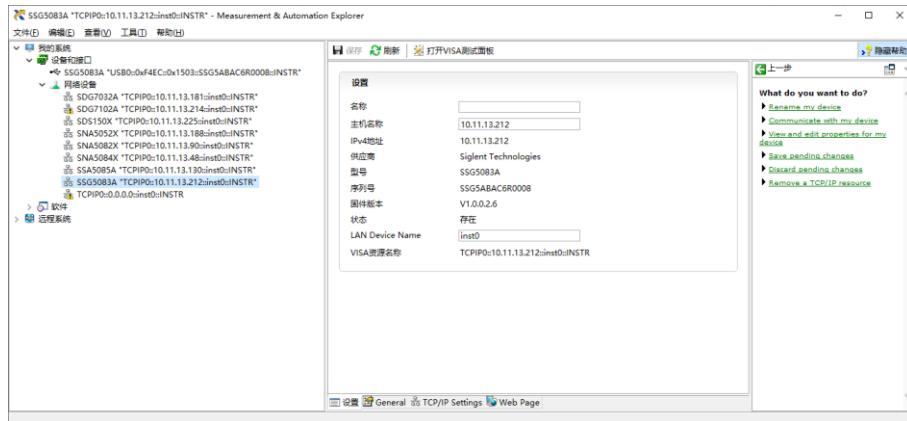

5. Right-click on the product and select Open NI-VISA Test Panel:

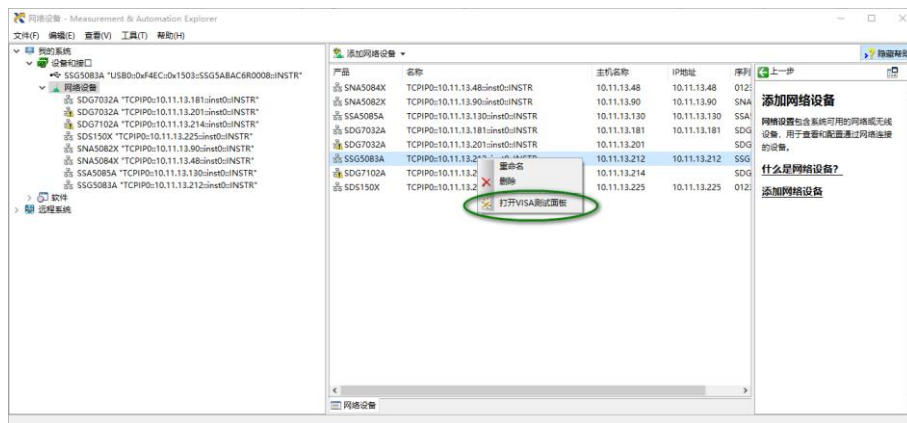

6. Click “Input/Output” option button and click “Query” option button. If everything is OK, you will see the Read operation information returned as shown below.

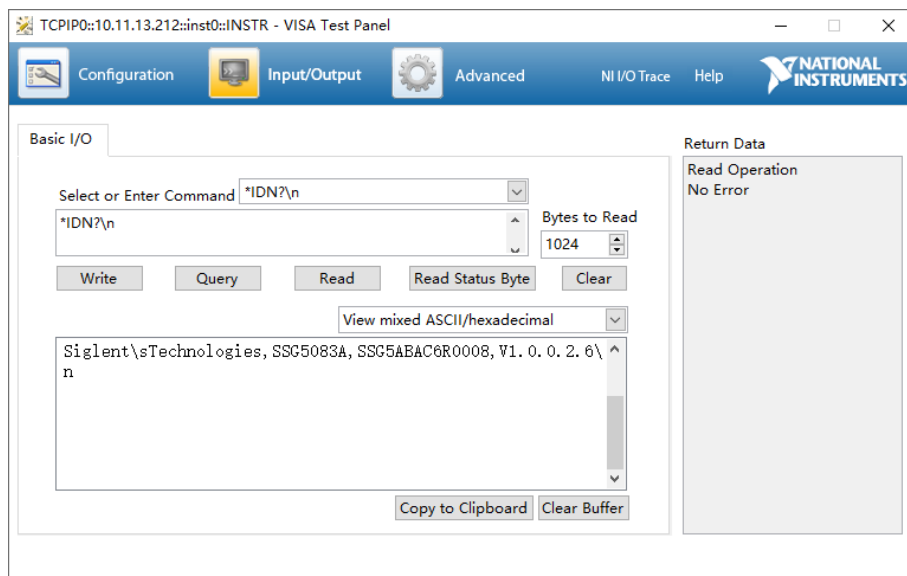

2 SCPI Overview

2.1 Command Format

SCPI commands present a hierarchical tree structure containing multiple subsystems; each of the subsystems is made up of a root keyword and several sub keywords. The command string usually starts with a colon “:”, the keywords are separated by a colon “:” and the parameter settings are separated by spaces. Query commands add a question mark “?” to the end of the string.

For example:

```
:SOURce:FREQuency <freq>
```

```
:SOURce:FREQuency?
```

SOURce is the root key of the command, FREQuency is second.

The command begins with “:”, and separates the keywords at the same time, <freq> separated by space and represents the parameter available for setting; “?” represents a query. A query sent to the instrument indicates that the instrument will have a response string. Therefore, queries ask a question and expect a response.

2.2 Symbol Instruction

The following four symbols are not the content of SCPI commands and cannot be sent with the commands, but are used to describe certain aspects of the commands.

1. Triangle Brackets < >

The parameter in the triangle brackets must be replaced by an effective value. For example:

Send the “POWER:SPC:TARGet <power>” command in “POWER:SPC:TARGet 0”.

2. Square Brackets []

The content in the square brackets can be ignored. When the parameter is ignored, the instrument will set the parameter to its default.

For example,

In the “[:SOURce]:POWer?” command, sending either of the commands below can generate the same effect:

```
:SOURce:POWer?
```

```
:POWer?
```

3. Vertical Bar |

The vertical bar is used to separate multiple parameters and when sending the command, you can choose one of the parameters.

For example,

In the “[:SOURce]:AM:STATe OFF|ON|0|1” command, the parameters available are “OFF”, “ON”, “0” or “1”.

4. Braces { }

The parameters in the braces are optional which can be ignored or set for one or more times.

2.3 Parameter Type

The parameters in the commands introduced in this manual include 6 types: Boolean, enumeration, integer, float and string.

1. Boolean

The parameter in the command could be “OFF”, “ON”, “0” or “1”.

For example:

```
[[:SOURce]:FM:STATe OFF|ON|0|1
```

2. Enumeration

The parameter could be any of the values listed.

For example:

```
[[:SOURce]:SWEep:STATe OFF|FREQuency|LEVe|LEV_FREQ
```

Valid parameters are “OFF”, “FREQuency”, “LEVe” or LEV_FREQ.

3. Integer

Except other notes, the parameter can be any integer within the effective value range.

For example:

```
[[:SOURce]:SWEep:STEP:POINts <value>
```

The parameter <value> can be set to any integer between 2 and 65535.

4. Float

The parameter can be any value within the effective value range according to the accuracy requirement (the default accuracy contains up to 9 digits after the decimal points).

For example:

```
[[:SOURce]:POWeR:OFFSet <value>
```

The parameter <value> can be set to any real number between -100 and 100.

5. String

The parameter should be the combinations of ASCII characters.

For example:

```
:SYSTem:COMMunicate:LAN:IPADdress <"xxx.xxx.xxx.xxx">
```

The IP address can be set as the string "192.168.1.12".

2.4 Command Abbreviation

All of the commands are not case sensitive, so you can use any of them. But if an abbreviation is used, all the capital letters in the command must be written completely.

For example:

```
:CORRection:FLATness:COUNT?
```

Can be abbreviated to:

```
:CORR:FLAT:COUN?
```

3 SCPI Commands

This chapter introduces the Siglent Technologies SSG5000A SCPI commands, including:

IEEE Common Commands	3.1
System Subsystem	3.2
Preset Subsystem	3.3
Output Subsystem	3.4
Source Subsystem	3.5
Sense Subsystem	3.6

3.1 IEEE Common Commands

3.1.1 Identification Query (*IDN)

Command Format	*IDN?
Instruction	Returns an instrument identification information string. The string contains the manufacturer, model number, serial number, software number, FPGA number and CPLD number.
Menu	None
Example	*IDN? Return: Siglent Technologies,SSG5083A,SSG5ABAC6R0008,V1.0.0.2.6

3.1.2 Reset (*RST)

Command Format	*RST
Instruction	This command presets the instrument to a factory defined condition that is appropriate for remote programming operation. *RST is equivalent to performing the two commands :SOURce:PRESet and *CLS. This command always performs a factory preset.
Menu	None
Example	*RST

3.1.3 Clear Status (*CLS)

Command Format	*CLS
Instruction	Clears the status byte register. It does this by emptying the error queue and clearing all bits in all of the event registers. The status byte register summarizes the states of the other registers. It is also responsible for generating service requests.
Menu	None
Example	*CLS

3.1.4 Standard Event Status Enable (*ESE)

Command Format	*ESE <number> *ESE?
Instruction	Set the bits in the standard event status enable register. This register monitors I/O errors and synchronization conditions such as operation complete, request control, query error, device dependent error, execution error, command error and power on. A summary bit is generated on execution of the command. The query returns the state of the standard event status enable register.
Menu	None
Example	*ESE 16

3.1.5 Standard Event Status Register Query (*ESR)

Command Format	*ESR?
Instruction	Queries and clears the standard event status event register. (This is a destructive read.) The value returned reflects the current state (0/1) of all the bits in the register.
Menu	None
Example	*ESR?

3.1.6 Operation Complete Query (*OPC)

Command Format	*OPC *OPC?
Instruction	<p>Set bit 0 in the standard event status register to “1” when all pending operations have finished.</p> <p>The query stops any new commands from being processed until the current processing is complete. Then it returns a “1”, and the program continues. This query can be used to synchronize events of other instruments on the external bus.</p> <p>Returns a “1” if the last processing is complete. Use this query when there’s a need to monitor the command execution status, such as a sweep execution.</p>
Menu	None
Example	*OPC?

3.1.7 Service Request Enable (*SRE)

Command Format	*SRE <integer> *SRE?
Instruction	<p>This command enables the desired bits of the service request enable register.</p> <p>The query returns the value of the register, indicating which bits are currently enabled.</p>
Menu	None
Example	*SRE 1

3.1.8 Status Byte Query (*STB)

Command Format	*STB
Instruction	This query is used by some instruments for a self test.
Menu	None
Example	*STB

3.1.9 Wait-to-Continue (*WAI)

Command Format	*WAI
Instruction	This command causes the instrument to wait until all pending commands are completed before executing any additional commands. There is no query form to the command.
Menu	None
Example	*WAI

3.1.10 Self Test Query (*TST)

Command Format	*TST?
Instruction	This query is used by some instruments for a self test.
Menu	None
Example	*TST?

3.2 System Subsystem

3.2.1 System Time (:SYSTem:TIME)

Command Format	:SYSTem:TIME <hhmmss> :SYSTem:TIME?
Instruction	Set the System time Get the System time
Parameter Type	String
Parameter Range	Hours(0 ~ 23), minutes(0 ~ 59), seconds(0 ~ 59)
Return	String
Default	None
Menu	Utility > Setting > Time Setting
Example	Set System time:

	:SYSTem:TIME 182559 Get System time: :SYSTem:TIME?
--	--

3.2.2 System Date (:SYSTem:DATE)

Command Format	:SYSTem:DATE <yyyymmdd> :SYSTem:DATE?
Instruction	Set system date Get system date
Parameter Type	String
Parameter Range	Years(four digits), month(1 ~ 12), date(1 ~ 31)
Return	String
Default	None
Menu	Utility > Setting > Time Setting
Example	Set System date: :SYSTem:DATE 20050101 Get System date: :SYSTem:DATE?

3.2.3 IP Address (:SYSTem:COMMunicate:LAN:IPADdress)

Command Format	:SYSTem:COMMunicate:LAN:IPADdress <"xxx.xxx.xxx.xxx"> :SYSTem:COMMunicate:LAN:IPADdress?
Instruction	Set the IP address. The IP address will be fetched automatically if the IP assignment is set to DHCP. Get the IP address
Parameter Type	String
Parameter Range	Conforms to the IP address standard(0-255:0-255:0-255:0-255)
Return	IP address string
Default	None
Menu	Utility > Interface > LAN Setting > IP Address

Example	:SYSTem:COMMunicate:LAN:IPADdress "192.168.1.12" :SYSTem:COMMunicate:LAN:IPADdress?
----------------	--

3.2.4 Gateway (:SYSTem:COMMunicate:LAN:GATeway)

Command Format	:SYSTem:COMMunicate:LAN:GATeway <"xxx.xxx.xxx.xxx"> :SYSTem:COMMunicate:LAN:GATeway?
Instruction	Set the gateway for the signal generator in the network. The gateway will be fetched automatically if the IP assignment is set to DHCP. Get the gateway.
Parameter Type	String
Parameter Range	Conforms to the IP standard (0~255.0~255.0~255.0~255)
Return	Gateway string
Default	None
Menu	Utility > Interface > LAN Setting > Gateway
Example	:SYSTem:COMMunicate:LAN:GATeway "192.168.1.1" :SYSTem:COMMunicate:LAN:GATeway?

3.2.5 Subnet Mask (:SYSTem:COMMunicate:LAN:SMASK)

Command Format	:SYSTem:COMMunicate:LAN:SMASK <"xxx.xxx.xxx.xxx"> :SYSTem:COMMunicate:LAN:SMASK?
Instruction	Set the subnet mask according to the network settings. The subnet mask will be set automatically if the IP assignment is set to DHCP. Get the subnet mask.
Parameter Type	String
Parameter Range	Conforms to the IP standard (0-255:0-255:0-255:0-255)
Return	Subnet mask string
Default	None
Menu	Utility > Interface > LAN Setting > Subnet Mask
Example	:SYSTem:COMMunicate:LAN:SMASK "255.255.255.0" :SYSTem:COMMunicate:LAN:SMASK?

3.2.6 IP Config (:SYSTem:COMMunicate:LAN:TYPE)

Command Format	:SYSTem:COMMunicate:LAN:TYPE STATIC DHCP :SYSTem:COMMunicate:LAN:TYPE?
Instruction	Toggles the IP assignment setting between static (manual) and DHCP (dynamic assignment) mode. Get the IP config mode.
Parameter Type	Enumeration
Parameter Range	STATIC DHCP
Return	Enumeration
Default	None
Menu	Utility > Interface > LAN Setting > DHCP State
Example	:SYSTem:COMMunicate:LAN:TYPE DHCP :SYSTem:COMMunicate:LAN:TYPE?

3.2.7 Language (SYSTem:LANGUage)

Command Format	:SYSTem:LANGUage CHINese ENGLish :SYSTem:LANGUage?
Instruction	Set language. Get language.
Parameter Type	Enumeration
Parameter Range	CHINese ENGLish
Return	Enumeration
Default	None
Menu	Utility > Setting > Language
Example	:SYSTem:LANGUage CHINese :SYSTem:LANGUage?

3.2.8 Screen Saver (SYSTem:SCReen:SAVer)

Command Format	SYSTem:SCReen:SAVer OFF 10S 1MIN 5MIN 15MIN 30MIN 1HOUR 2HOUR SYSTem:SCReen:SAVer?
Instruction	Set screen saver. Get screen saver.
Parameter Type	Enumeration
Parameter Range	OFF 10S 1MIN 5MIN 15MIN 30MIN 1HOUR 2HOUR
Return	Enumeration
Default	OFF
Menu	Utility > Setting > Screen Saver
Example	SYSTem:SCReen:SAVer 30MIN SYSTem:SCReen:SAVer?

3.2.9 Beeper (SYSTem:ALARm)

Command Format	SYSTem:ALARm ON OFF 1 0 SYSTem:ALARm?
Instruction	Set system beeper state. Get system beeper state.
Parameter Type	Boolean
Parameter Range	ON OFF 1 0
Return	Boolean
Default	ON
Menu	Utility > Setting > Beeper
Example	SYSTem:ALARm ON SYSTem:ALARm?

3.2.10 Setup Type (:SYSTem:PON:TYPE)

Command Format	:SYSTem:PON:TYPE DFT LAST :SYSTem:PON:TYPE?
Instruction	Sets the signal generator power on state. Default is the factory configuration and last recalls all of the settings used before the last power down. Get power on type.
Parameter Type	Enumeration
Parameter Range	DFT LAST DFT: Default LAST: Last
Return	Enumeration
Default	DFT
Menu	Utility > Setting > Setup Type
Example	:SYSTem:PON:TYPE DFT :SYSTem:PON:TYPE?

3.2.11 Power On Line (SYSTem:POWeron:TYPE)

Command Format	SYSTem:POWeron:TYPE ON OFF 1 0 SYSTem:POWeron:TYPE?
Instruction	Set the signal generator power on line state. Get the signal generator power on line state.
Parameter Type	Boolean
Parameter Range	ON OFF 1 0
Return	Boolean
Default	OFF
Menu	Utility > Setting > Power On Line
Example	SYSTem:POWeron:TYPE ON SYSTem:POWeron:TYPE?

3.2.12 10M Adjustment State (:SYSTem:REF:DAC:STAT)

Command Format	:SYSTem:REF:DAC:STAT ON OFF 1 0 :SYSTem:REF:DAC:STAT?
Instruction	Set 10M Adjustment State. Get 10M Adjustment State.
Parameter Type	Boolean
Parameter Range	ON OFF 1 0
Return	Boolean
Default	0
Menu	Utility > Setting > 10M Adjustment
Example	:SYSTem:REF:DAC:STAT ON :SYSTem:REF:DAC:STAT?

3.2.13 Ref Osc Code (:SYSTem:REF:DAC)

Command Format	:SYSTem:REF:DAC <value> :SYSTem:REF:DAC?
Instruction	Set ref osc code. Get ref osc code.
Parameter Type	Int
Parameter Range	0 ~ 65535
Return	Int
Default	26214
Menu	Utility > Setting > 10M Adjustment > Ref Osc Code
Example	:SYSTem:REF:DAC 43000 :SYSTem:REF:DAC?

3.2.14 Ref Osc Code Store (:SYSTEM:REF:DAC:SAVE)

Command Format	:SYSTEM:REF:DAC:SAVE <file_name>
Instruction	Save the ref osc code in file.
Parameter Type	String
Parameter Range	None
Return	None
Default	None
Menu	Utility > Setting > 10M Adjustment > Save Ref Osc Setting
Example	:SYSTEM:REF:DAC:SAVE "U-disk3/test.dac"

3.2.15 Ref Osc Code Load (:SYSTEM:REF:DAC:LOAD)

Command Format	:SYSTEM:REF:DAC:LOAD <file_name>
Instruction	Load existing ref osc code files.
Parameter Type	String
Parameter Range	None
Return	None
Default	None
Menu	Utility > Setting > 10M Adjustment > Recall Ref Osc Setting
Example	:SYSTEM:REF:DAC:LOAD "U-disk3/test.dac"

3.2.16 Reset Ref Osc Code to Default (:SYSTEM:REF:DAC:DEFault)

Command Format	:SYSTEM:REF:DAC:DEFault
Instruction	Reset ref osc code to default value.
Parameter Type	None
Parameter Range	None
Return	None

Default	None
Menu	Utility > Setting > 10M Adjustment > Reset to Default
Example	:SYSTem:REF:DAC:DEFAult

3.2.17 GPIB Address (SYSTem:GPIB)

Command Format	SYSTem:GPIB <value> SYSTem:GPIB?
Instruction	Set GPIB address of the signal source. Get GPIB address of the signal source.
Parameter Type	Integer
Parameter Range	1 ~ 30
Return	Integer
Default	18
Menu	Utility > Interface > GPIB Address
Example	SYSTem:GPIB 10 SYSTem:GPIB?

3.3 Preset Subsystem

3.3.1 Preset (:SOURce:PRESet)

Command Format	:SOURce:PRESet
Instruction	Presets all parameters which are related to the selected signal path
Parameter Type	None
Return	None
Default	None
Menu	None
Example	SOUR:PRES

3.3.2 System Preset (:SYSTEM:PRESet)

Command Format	:SYSTEM:PRESet
Instruction	According to the preset type, preset the parameter configuration of the machine.
Parameter Type	None
Return	None
Default	None
Menu	Utility > Preset
Example	<p>For example, preset signal generator to default configuration:</p> <pre>:SYSTEM:PRESet:TYPE DFT :SYSTEM:PRES</pre> <p>Or preset signal generator to current configuration:</p> <pre>:SYSTEM:PRESet:TYPE USER :SYSTEM:PRESet:SAVE :SYSTEM:PRES</pre> <p>Or preset signal generator to configuration saved in an existing xml file:</p> <pre>:SYSTEM:PRESet:TYPE USER :SYSTEM:PRESet:PATH "Local/test.xml" :SYSTEM:PRES</pre>

3.3.3 Preset Save (:SYSTEM:PRESet:SAVE)

Command Format	:SYSTEM:PRESet:SAVE
Instruction	Save status for preset when preset type is user
Parameter Type	None
Return	None
Default	None
Menu	Utility > Preset
Example	:SYSTEM:PRESet:SAVE

3.3.4 Preset Path (:SYSTem:PRESet:PATH)

Command Format	:SYSTem:PRESet:PATH <path>
Instruction	Set preset file when preset type is user
Parameter Type	String
Return	None
Default	None
Menu	Utility > Setting > Preset Type
Example	:SYSTem:PRESet:PATH "Local/test.xml" :SYSTem:PRESet:PATH "U-disk1/test.xml"

3.3.5 Preset Type (:SYSTem:PRESet:TYPE)

Command Format	:SYSTem:PRESet:TYPE DFT USER :SYSTem:PRESet:TYPE?
Instruction	Uses this command to preset the signal generator to default or user. Get preset type.
Parameter Type	Enumeration
Parameter Range	DFT: Default USER: Custom Configuration
Return	Enumeration
Default	DFT
Menu	Utility > Setting > Preset Type
Example	:SYSTem:PRESet:TYPE DFT :SYSTem:PRESet:TYPE?

3.3.6 Factory Reset (:SYSTem:FDEFault)

Command Format	:SYSTem:FDEFault
Instruction	Set both the measure and setting parameters to the factory settings.
Parameter Type	None
Parameter Range	None
Return	None
Default	None
Menu	Utility > Setting > Factory Reset
Example	:SYSTem:FDEFault

3.3.7 Reset & Clear (SYSTem:RESet:CLEAr)

Command Format	SYSTem:RESet:CLEAr
Instruction	Set both the measure and setting parameters to the factory settings, and at the same time clear the files saved by the user in the "Local" folder.
Parameter Type	None
Parameter Range	None
Return	None
Default	None
Menu	Utility > Setting > Reset & Clear
Example	SYSTem:RESet:CLEAr

3.4 Output Subsystem

3.4.1 RF Output (:OUTPut[:STATe])

Command Format	:OUTPut[:STATe] ON OFF 1 0 :OUTPut[:STATe]?
Instruction	Activate/Deactivate the RF output Get the state of the RFoutput
Parameter Type	Boolean
Parameter Range	ON OFF 1 0
Return	Boolean
Default	0
Menu	RF
Example	:OUTPut ON :OUTPut?

3.4.2 RF Output ([:SOURce]:OUTPut)

Command Format	[:SOURce]:OUTPut ON OFF 1 0
Instruction	Activate/Deactivate the RF output
Parameter Type	Boolean
Parameter Range	ON OFF 1 0
Return	None
Default	0
Menu	RF
Example	SOURce:OUTPut ON

3.5 Source Subsystem

3.5.1 [:SOURce]:FREQUENCY Subsystem

3.5.1.1 Frequency Display ([:SOURce]:FREQUENCY:DISPlay)

Command Format	[:SOURce]:FREQUENCY:DISPlay <freq> [:SOURce]:FREQUENCY:DISPlay?
Instruction	Set the frequency display on parameter bar Get the frequency display on parameter bar
Parameter Type	Float, unit: Hz, kHz, MHz, GHz, Default "Hz"
Parameter Range	Frequency offset + Full frequency range
Return	Float, unit: Hz
Default	Maximum frequency
Menu	Freq
Example	FREQUENCY:DISPlay 2 MHz :FREQUENCY:DISPlay?

3.5.1.2 Frequency ([:SOURce]:FREQUENCY)

Command Format	[:SOURce]:FREQUENCY <freq> [:SOURce]:FREQUENCY?
Instruction	Set the frequency of the RF output signal Get the frequency of the RF output signal
Parameter Type	Float, unit: Hz, kHz, MHz, GHz, Default "Hz"
Parameter Range	Full frequency range
Return	Float, unit: Hz
Default	Maximum frequency
Menu	FREQ > Frequency
Example	FREQUENCY 2 MHz :FREQUENCY?

3.5.1.3 Frequency Offset ([:SOURce]:FREQuency:OFFSet)

Command Format	[:SOURce]:FREQuency:OFFSet <freq> [:SOURce]:FREQuency:OFFSet?
Instruction	Set the frequency offset of a downstream circuit element Get the frequency offset of a downstream circuit element
Parameter Type	Float, unit: Hz, kHz, MHz, GHz, Default "Hz"
Parameter Range	-200 GHz ~ 200 GHz
Return	Float, unit: Hz
Default	0 Hz
Menu	FREQ > Freq Offset
Example	FREQuency:OFFSet 2 MHz FREQuency:OFFSet?

3.5.1.4 Phase Offset ([:SOURce]:PHASe)

Command Format	[:SOURce]:PHASe <phase> [:SOURce]:PHASe?
Instruction	Set the phase of the RF output signal Get the phase of the RF output signal
Parameter Type	Float, unit: deg
Parameter Range	-360 deg ~ 360 deg
Return	Float, unit: deg
Default	0 deg
Menu	FREQ > Phase Offset
Example	PHASe 20 PHASe?

3.5.1.5 Phase Reset ([:SOURce]:PHASe:RESet [:SOURce]:PHASe:REF)

Command Format	[:SOURce]:PHASe:RESet [:SOURce]:PHASe:REF
Instruction	Set the current phase to zero
Parameter Type	None
Parameter Range	None
Return	None
Default	None
Menu	FREQ > Reset phase delta display
Example	:PHASe:RESet :PHASe:REF

3.5.2 [:SOURce]:POWER Subsystem

3.5.2.1 Level Display ([:SOURce]:POWER:POWER)

Command Format	[:SOURce]:POWER:POWER <power> [:SOURce]:POWER:POWER?
Instruction	Set the RF level display on parameter bar Get the RF level display from the parameter bar
Parameter Type	Float, unit: dBm, dBuV, uV, mV, V, nW, uW, mW, W, Default: dBm
Parameter Range	Level Offset + Full power range
Return	Float, unit: dBm
Default	-130 dBm
Menu	Level
Example	POWER:POWER 2 POWER:POWER?

3.5.2.2 Level ([:SOURce]:POWer)

Command Format	[:SOURce]:POWer <power> [:SOURce]:POWer?
Instruction	Set the RF output level Get the RF output level
Parameter Type	Float, unit: dBm, dBuV, uV, mV, V, nW, uW, mW, W, Default: dBm
Parameter Range	Please refer to SSG5000A datasheet.
Return	Float, unit: dBm
Default	-130 dBm
Menu	LEVEL > Level
Example	POWer 2 :POWer?

3.5.2.3 Level ([:SOURce]:POWer[:LEVel][:IMMediate][:AMPLitude])

Command Format	[:SOURce]:POWer[:LEVel][:IMMediate][:AMPLitude] <power> [:SOURce]:POWer[:LEVel][:IMMediate][:AMPLitude]?
Instruction	Set the RF output level Get the RF output level
Parameter Type	Float, unit: dBm, dBuV, uV, mV, V, nW, uW, mW, W, Default: dBm
Parameter Range	Please refer to SSG5000A datasheet.
Return	Float, unit: dBm
Default	-130 dBm
Menu	LEVEL > Level
Example	POWer:LEVel -5 :POWer:LEVel?

3.5.2.4 Level Offset ([:SOURce]:POWer:OFFSet)

Command Format	[:SOURce]:POWer:OFFSet <power> [:SOURce]:POWer:OFFSet?
Instruction	Set the RF offset level of the RF output Get the RF offset level of the RF output
Parameter Type	Float
Parameter Range	-100 dB ~ 100 dB
Return	Float, unit: dB
Default	0 dB
Menu	LEVEL > Level Offset
Example	POWer:OFFSet 2 POWer:OFFSet?

3.5.2.5 ALC State ([:SOURce]:POWer:ALC)

Command Format	[:SOURce]:POWer:ALC ON OFF AUTO [:SOURce]:POWer:ALC?
Instruction	Activate/deactivate automatic level control. Query ALC state
Parameter Type	Enumeration
Parameter Range	ON OFF AUTO ON Internal level control is permanently activated. OFF Internal level control is deactivated; Sample & Hold mode is activated. AUTO Internal level control is activated/deactivated automatically depending on the operating state.
Return	Enumeration
Default	AUTO
Menu	LEVEL > ALC State
Example	POWer:ALC ON

	POWer:ALC?
--	------------

3.5.2.6 Flatness List State ([:SOURce]:CORRection[:FLATness])

Command Format	[:SOURce]:CORRection[:FLATness] ON OFF 1 0 [:SOURce]:CORRection[:FLATness]?
Instruction	Activate/deactivate flatness correction list.
Parameter Type	Boolean
Parameter Range	ON OFF 1 0
Return	Boolean
Default	0
Menu	LEVEL > Flatness
Example	CORRection:FLATness ON :CORRection?

3.5.2.7 Flatness List Add Row ([:SOURce]:CORRection:FLATness:PAIR)

Command Format	[:SOURce]:CORRection:FLATness:PAIR <freq>, <power>
Instruction	Insert a new row in the flatness list.
Parameter Type	Float, Float
Parameter Range	Freq: Full freq range Power: Full power range
Return	None
Default	None
Menu	LEVEL > Flatness > Add
Example	CORRection:FLATness:PAIR 3 MHz, -3

3.5.2.8 Flatness List Delete Row ([:SOURce]:CORRection:FLATness:DELeTe)

Command Format	[:SOURce]:CORRection:FLATness:DELeTe <row>
-----------------------	--

Instruction	Delete the selected row in the flatness list.
Parameter Type	Integer
Parameter Range	Less than the total count of the flatness.
Return	None
Default	None
Menu	LEVEL > Flatness > Delete
Example	CORRection:FLATness:DELeTe 0

3.5.2.9 Flatness List Count ([:SOURce]:CORRection:FLATness:COUNT?)

Command Format	[:SOURce]:CORRection:FLATness:COUNT?
Instruction	Indicates the total count of the number of elements in the flatness correction table
Parameter Type	None
Parameter Range	None
Return	Integer
Default	0
Menu	LEVEL > Flatness
Example	CORRection:FLATness:COUNT?

3.5.2.10 Flatness List Store ([:SOURce]:CORRection:STORE)

Command Format	[:SOURce]:CORRection:STORE <file_name>
Instruction	Save the correction data in the list
Parameter Type	String
Parameter Range	None
Return	None
Default	None
Menu	LEVEL > Flatness > Save

Example	:CORRection:STORe "U-disk3/test.uflt"
----------------	---------------------------------------

3.5.2.11 Flatness List Load ([:SOURce]:CORRection:LOAD)

Command Format	[:SOURce]:CORRection:LOAD <file_name>
Instruction	Load an existing flatness correction file
Parameter Type	String
Parameter Range	None
Return	None
Default	None
Menu	LEVEL > Flatness > Load
Example	:CORRection:LOAD "U-disk3/test.uflt"

3.5.2.12 Flatness List Clear ([:SOURce]:CORRection:FLATness:PRESet)

Command Format	[:SOURce]:CORRection:FLATness:PRESet
Instruction	Clear the displayed flatness correction list
Parameter Type	None
Parameter Range	None
Default	None
Menu	LEVEL > Flatness > Clear
Example	:CORRection:FLATness:PRESet

3.5.2.13 Flatness List Fill Type ([:SOURce]:CORRection:FLATness:FILL:TYPE)

Command Format	[:SOURce]:CORRection:FLATness:FILL:TYPE FLATness MANUal SWEEPlist [:SOURce]:CORRection:FLATness:FILL:TYPE?
Instruction	Set the Fill Type to generate flatness list. Get the Fill Type to generate flatness list.

Parameter Type	Enumeration
Parameter Range	FLATness MANUal SWEEPlist
Return	Enumeration
Default	FLATness
Menu	LEVEL > Flatness > Setting > Fill Type
Example	:CORRection:FLATness:FILL:TYPE FLATness :CORRection:FLATness:FILL:TYPE?

3.5.2.14 Flatness List Start Freq ([:SOURce]:CORRection:FLATness:STARTfreq)

Command Format	:[:SOURce]:CORRection:FLATness:STARTfreq <freq> [:SOURce]:CORRection:FLATness:STARTfreq?
Instruction	Set the start frequency when you want to fill the flatness list with the sensor and filling type is "Manual Step". Get the start frequency when you want to fill the flatness list with the sensor and filling type is "Manual Step".
Parameter Type	Float, unit: Hz, kHz, MHz, GHz, Default "Hz"
Parameter Range	Full frequency range
Return	Float, unit: Hz
Default	Maximum frequency
Menu	LEVEL > Flatness > Setting > Fill Type > Manual Step > Start Freq
Example	:CORRection:FLATness:STARTfreq 200 MHz :CORRection:FLATness:STARTfreq?

3.5.2.15 Flatness List Stop Freq ([:SOURce]:CORRection:FLATness:STOPfreq)

Command Format	:[:SOURce]:CORRection:FLATness:STOPfreq <freq> [:SOURce]:CORRection:FLATness:STOPfreq?
Instruction	Set the stop frequency when you want to fill the flatness list with the sensor and filling type is "Manual Step". Get the stop frequency when you want to fill the flatness list with the sensor and filling type is "Manual Step".

Parameter Type	Float, unit: Hz, kHz, MHz, GHz, Default “Hz”
Parameter Range	Full frequency range
Return	Float, unit: Hz
Default	Maximum frequency
Menu	LEVEL > Flatness > Setting > Fill Type > Manual Step > Stop Freq
Example	:CORRection:FLATness:STOPfreq 500 MHz :CORRection:FLATness:STOPfreq?

3.5.2.16 Flatness List Fill Space ([:SOURce]:CORRection:FLATness:SPACE)

Command Format	[:SOURce]:CORRection:FLATness:SPACE LINear LOGarithmic [:SOURce]:CORRection:FLATness:SPACE?
Instruction	Set the fill space in Manual Step Fill Type. Get the fill space in Manual Step Fill Type.
Parameter Type	Enumeration
Parameter Range	LINear LOGarithmic
Return	Enumeration
Default	LINear
Menu	LEVEL > Flatness > Setting > Fill Type > Manual Step > Fill Space
Example	:CORRection:FLATness:SPACE LINear :CORRection:FLATness:SPACE?

3.5.2.17 Flatness List Linear Step ([:SOURce]:CORRection:FLATness:LINStep)

Command Format	[:SOURce]:CORRection:FLATness:LINStep <freq> [:SOURce]:CORRection:FLATness:LINStep?
Instruction	Set the linear frequency step in Manual Step Fill Type. Get the linear frequency step in Manual Step Fill Type.
Parameter Type	Float, unit: Hz, kHz, MHz, GHz, Default “Hz”
Parameter Range	None

Return	Float, unit: Hz
Default	None
Menu	LEVEL > Flatness > Setting > Fill Type > Manual Step > Step Linear
Example	:CORRection:FLATness:LINStep 200 MHz :CORRection:FLATness:LINStep?

3.5.2.18 Flatness List Log Step ([:SOURce]:CORRection:FLATness:LOGStep)

Command Format	[:SOURce]:CORRection:FLATness:LOGStep <value> [:SOURce]:CORRection:FLATness:LOGStep?
Instruction	Set the log frequency step in Manual Step Fill Type. Get the log frequency step in Manual Step Fill Type.
Parameter Type	Float, unit: %
Parameter Range	None
Return	Float, unit: %
Default	None
Menu	LEVEL > Flatness > Setting > Fill Type > Manual Step > Step Log
Example	:CORRection:FLATness:LOGStep 20 :CORRection:FLATness:LOGStep?

3.5.2.19 Flatness List Points ([:SOURce]:CORRection:FLATness:POINT)

Command Format	[:SOURce]:CORRection:FLATness:POINT <points> [:SOURce]:CORRection:FLATness:POINT?
Instruction	Set the points of flatness list in Manual Step Fill Type. Get the points of flatness list in Manual Step Fill Type.
Parameter Type	Integer
Parameter Range	2 ~ 500
Return	Integer
Default	11
Menu	LEVEL > Flatness > Setting > Fill Type > Manual Step > Points

Example	:CORRection:FLATness:POINt 5 :CORRection:FLATness:POINt?
----------------	---

3.5.2.20 Fill Flatness with Sensor

([:SOURce]:CORRection:CSET:DATA[:SENSor][:POWER]:SONCe)

Command Format	[:SOURce]:CORRection:CSET:DATA[:SENSor][:POWER]:SONCe
Instruction	Fill the level values of the flatness list with the power meter.
Parameter Type	None
Parameter Range	None
Return	None
Default	None
Menu	LEVEL > Flatness > Setting > Fill Flatness with Sensor
Example	:CORRection:CSET:DATA:SONCe

3.5.2.21 Level Control ([:SOURce]:POWER:SPC:STATe)

Command Format	[:SOURce]:POWER:SPC:STATe ON OFF 1 0 [:SOURce]:POWER:SPC:STATe?
Instruction	Activate/Deactivate power control using an external USB power sensor Get the level control state
Parameter Type	Boolean
Parameter Range	ON OFF 1 0
Return	Boolean
Default	0
Menu	SENSOR > Level Control
Example	POWER:SPC:STATe ON :POWER:SPC:STATe?

3.5.2.22 Level Control (:SENSe[:POWer]:LEV:CTL:STATe)

Command Format	:SENSe[:POWer]:LEV:CTL:STATe ON OFF 1 0 :SENSe[:POWer]:LEV:CTL:STATe?
Instruction	Activate/Deactivate power control using an external USB power sensor Get the level control state
Parameter Type	Boolean
Parameter Range	ON OFF 1 0
Return	Boolean
Default	0
Menu	SENSOR > Level Control
Example	:SENSe:LEV:CTL:STATe OFF :SENSe:LEV:CTL:STATe?

3.5.2.23 Target Level ([:SOURce]:POWer:SPC:TARGet)

Command Format	[:SOURce]:POWer:SPC:TARGet <power> [:SOURce]:POWer:SPC:TARGet?
Instruction	Set the nominal level expected at the input of the sensor Get the nominal level expected at the input of the sensor
Parameter Type	Float, unit: dBm, dBuV, uV, mV, V, nW, uW, mW, W, Default: dBm
Parameter Range	-120 dBm ~ 20 dBm
Return	Float, unit: dBm
Default	0 dBm
Menu	SENSOR > Level Control > Target Level
Example	POWer:SPC:TARGet 0 POWer:SPC:TARGet?

3.5.2.24 Target Level (:SENSe[:POWer]:SPC:TARGet)

Command Format	:SENSe[:POWer]:SPC:TARGet <power> :SENSe[:POWer]:SPC:TARGet?
Instruction	Set the nominal level expected at the input of the sensor Get the nominal level expected at the input of the sensor
Parameter Type	Float, unit: dBm, dBuV, uV, mV, V, nW, uW, mW, W, Default: dBm
Parameter Range	-120 dBm ~ 20 dBm
Return	Float, unit: dBm
Default	0 dBm
Menu	SENSOR > Level Control > Target Level
Example	SENSe:SPC:TARGet -6 SENSe:SPC:TARGet?

3.5.2.25 Level Limit ([:SOURce]:POWer:LIMit)

Command Format	[:SOURce]:POWer:LIMit <power> [:SOURce]:POWer:LIMit?
Instruction	Set the upper limit for the RF output power Get the upper limit for the RF output power
Parameter Type	Float, unit: dBm, dBuV, uV, mV, V, nW, uW, mW, W, Default: dBm
Parameter Range	-120 dBm ~ 20 dBm
Return	Float, unit: dBm
Default	0 dBm
Menu	SENSOR > Level Control > Level Limit
Example	POWer:LIMit 1 POWer:LIMit?

3.5.2.26 Level Limit (:SENSe[:POWer]:LIMit)

Command Format	:SENSe[:POWer]:LIMit <power> :SENSe[:POWer]:LIMit?
Instruction	Set the upper limit for the RF output power Get the upper limit for the RF output power
Parameter Type	Float, unit: dBm, dBuV, uV, mV, V, nW, uW, mW, W, Default: dBm
Parameter Range	-120 dBm ~ 20 dBm
Return	Float, unit: dBm
Default	0 dBm
Menu	SENSOR > Level Control > Level Limit
Example	SENSe:LIMit 2 SENSe:LIMit?

3.5.2.27 Catch Range ([:SOURce]:POWer:SPC:CRANge)

Command Format	[SOURce]:POWer:SPC:CRANge <power> [SOURce]:POWer:SPC:CRANge?
Instruction	Set the capture range of the control system Get the capture range of the control system
Parameter Type	Float, unit: dB
Parameter Range	0 dB ~ 50 dB
Return	Float, unit: dB
Default	0 dB
Menu	SENSOR > Level Control > Catch Range
Example	:POWer:SPC:CRANge 5 :POWer:SPC:CRANge?

3.5.2.28 Catch Range (:SENSe[:POWer]:SPC:CRANge)

Command Format	:SENSe[:POWer]:SPC:CRANge <power> :SENSe[:POWer]:SPC:CRANge?
Instruction	Set the capture range of the control system Get the capture range of the control system
Parameter Type	Float, unit: dB
Parameter Range	0 dB ~ 50 dB
Return	Float, unit: dB
Default	0 dB
Menu	SENSOR > Level Control > Catch Range
Example	:SENSe:SPC:CRANge 10 :SENSe:SPC:CRANge?

3.5.3 [:SOURce]:SWEep Subsystem

3.5.3.1 Sweep State (:SOURce):SWEep:STATe)

Command Format	[:SOURce]:SWEep:STATe OFF FREQuency LEVel LEV_FREQ [:SOURce]:SWEep:STATe?
Instruction	Activate frequency or/and level sweep
Parameter Type	Enumeration
Parameter Range	OFF FREQuency LEVel LEV_FREQ
Return	Enumeration
Default	OFF
Menu	SWEEP > Sweep State
Example	:SWEep:STATe OFF :SWEep:STATe?

3.5.3.2 Sweep Type ([:SOURce]:SWEep:TYPE)

Command Format	[:SOURce]:SWEep:TYPE LIST STEP [:SOURce]:SWEep:TYPE?
Instruction	Set sweep type Get sweep type
Parameter Type	Enumeration
Parameter Range	LIST STEP
Return	Enumeration
Default	STEP
Menu	SWEEP > Step Sweep / List Sweep
Example	:SWEep:TYPE STEP :SWEep:TYPE?

3.5.3.3 Start Frequency ([:SOURce]:SWEep:STEP:START:FREQuency)

Command Format	[:SOURce]:SWEep:STEP:START:FREQuency <freq> [:SOURce]:SWEep:STEP:START:FREQuency?
Instruction	Set the start frequency for the sweep mode Get the start frequency for the sweep mode
Parameter Type	Float, unit: Hz, kHz, MHz, GHz, Default "Hz"
Parameter Range	Full frequency range.
Return	Float, unit: Hz
Default	Maximum frequency
Menu	SWEEP > Step Sweep > Start Freq
Example	:SWEep:STEP:START:FREQuency 1 GHz :SWEep:STEP:START:FREQuency?

3.5.3.4 Stop Frequency ([:SOURce]:SWEep:STEP:STOP:FREQuency)

Command Format	[:SOURce]:SWEep:STEP:STOP:FREQuency <freq> [:SOURce]:SWEep:STEP:STOP:FREQuency?
Instruction	Set the stop frequency for the sweep mode Get the stop frequency for the sweep mode
Parameter Type	Float, unit: Hz, kHz, MHz, GHz, Default "Hz"
Parameter Range	Full frequency range.
Return	Float, unit: Hz
Default	Maximum frequency
Menu	SWEEP > Step Sweep > Stop Freq
Example	:SWEep:STEP:STOP:FREQuency 1 GHz :SWEep:STEP:STOP:FREQuency?

3.5.3.5 Start Level ([:SOURce]:SWEep:STEP:STARt:LEVel)

Command Format	[:SOURce]:SWEep:STEP:STARt:LEVel <level> [:SOURce]:SWEep:STEP:STARt:LEVel?
Instruction	Set the start level for the sweep mode Get the start level for the sweep mode
Parameter Type	Float, unit: dBm, dBuV, uV, mV, V, nW, uW, mW, W, Default: dBm
Parameter Range	Full level range.
Return	Float, unit: dBm
Default	-130 dBm
Menu	SWEEP > Step Sweep > Start Level
Example	:SWEep:STEP:STARt:LEVel 0 dBm :SWEep:STEP:STARt:LEVel?

3.5.3.6 Stop Level ([:SOURce]:SWEep:STEP:STOP:LEVel)

Command Format	[:SOURce]:SWEep:STEP:STOP:LEVel <level> [:SOURce]:SWEep:STEP:STOP:LEVel?
Instruction	Set the stop level for the sweep mode Get the stop level for the sweep mode
Parameter Type	Float, unit: dBm, dBuV, uV, mV, V, nW, uW, mW, W, Default dBm
Parameter Range	Full level range.
Return	Float, unit: dBm
Default	-130 dBm
Menu	SWEEP > Step Sweep > Stop Level
Example	:SWEep:STEP:STOP:LEVel 0 dBm :SWEep:STEP:STOP:LEVel?

3.5.3.7 Dwell Time ([:SOURce]:SWEep:STEP:DWELI)

Command Format	[:SOURce]:SWEep:STEP:DWELI <time> [:SOURce]:SWEep:STEP:DWELI?
Instruction	Set the duration of the individual sweep steps Get the duration of the individual sweep steps
Parameter Type	Float, unit: ns, us, ms, s
Parameter Range	10 ms ~ 100 s
Return	Float, unit: s
Default	30 ms
Menu	SWEEP > Step Sweep > Dwell Time
Example	:SWEep:STEP:DWELI 20 ms :SWEep:STEP:DWELI?

3.5.3.8 Sweep Points ([:SOURce]:SWEep:STEP:POINts)

Command Format	[:SOURce]:SWEep:STEP:POINts <points> [:SOURce]:SWEep:STEP:POINts?
Instruction	Set the number of steps in an RF sweep Get the number of steps in an RF sweep
Parameter Type	Integer
Parameter Range	2 ~ 65535
Return	Integer
Default	11
Menu	SWEEP > Step Sweep > Sweep Points
Example	:SWEep:STEP:POINts 2 :SWEep:STEP:POINts?

3.5.3.9 Sweep Shape ([:SOURce]:SWEep:STEP:SHAPE)

Command Format	[:SOURce]:SWEep:STEP:SHAPE TRIangle SAWtooth [:SOURce]:SWEep:STEP:SHAPE?
Instruction	Select the waveform shape of the sweep signal Get the waveform shape of the sweep signal
Parameter Type	Enumeration
Parameter Range	TRIangle SAWtooth
Return	Enumeration
Default	SAWTooth
Menu	SWEEP > Step Sweep > Sweep Shape
Example	:SWEep:STEP:SHAPE TRIangle :SWEep:STEP:SHAPE?

3.5.3.10 Sweep Space ([:SOURce]:SWEep:STEP:SPACe)

Command Format	[:SOURce]:SWEep:STEP:SPACe LINear LOGarithmic [:SOURce]:SWEep:STEP:SPACe?
Instruction	Select the sweep spacing Get the sweep spacing
Parameter Type	Enumeration
Parameter Range	LINear LOGarithmic
Return	Enumeration
Default	LINear
Menu	SWEEP > Step Sweep > Sweep Space
Example	:SWEep:STEP:SPACe LOGarithmic :SWEep:STEP:SPACe?

3.5.3.11 Sweep Step in Linear Sweep Space

([:SOURce]:SWEep[:FREQuency]:STEP[:LINear])

Command Format	[:SOURce]:SWEep[:FREQuency]:STEP[:LINear] <freq> [:SOURce]:SWEep[:FREQuency]:STEP[:LINear]?
Instruction	Set the sweep step in linear sweep space. Get the sweep step in linear sweep space.
Parameter Type	Float, unit: Hz, kHz, MHz, GHz, Default "Hz"
Parameter Range	None
Return	Float, unit: Hz
Default	0
Menu	SWEEP > Step Sweep > Freq Step Linear
Example	:SWEep:STEP 200 MHz :SWEep:STEP?

3.5.3.12 Sweep Step in Log Sweep Space

([:SOURce]:SWEep[:FREQUENCY]:STEP:LOGarithmic)

Command Format	[:SOURce]:SWEep[:FREQUENCY]:STEP:LOGarithmic <value> [:SOURce]:SWEep[:FREQUENCY]:STEP:LOGarithmic?
Instruction	Set the sweep step in logarithmic sweep space. Get the sweep step in logarithmic sweep space.
Parameter Type	Float, unit: %
Parameter Range	None
Return	Float, unit: %
Default	0
Menu	SWEEP > Step Sweep > Freq Step Log
Example	:SWEep:STEP:LOGarithmic 20 :SWEep:STEP:LOGarithmic?

3.5.3.13 Sweep List Add Row ([:SOURce]:SWEep:LIST:ADDList)

Command Format	[:SOURce]:SWEep:LIST:ADDList <freq>,<level>,<time>
Instruction	Insert a new row to the list
Parameter Type	Freq: Float, unit: Hz, kHz, MHz, GHz, Default "Hz" Level: Float, unit: dBm Time: Float, unit: ns, us, ms, s, Default "s"
Parameter Range	Full frequency range, full frequency range, 10.0 ms ~ 100.0 s
Return	None
Default	None
Menu	SWEEP > List Sweep > Add
Example	:SWEep:LIST:ADDList 1 GHz,0 dBm,1 s

3.5.3.14 Sweep List Delete Row ([:SOURce]:SWEep:LIST:DELeTe)

Command Format	[:SOURce]:SWEep:LIST:DELeTe <row>
Instruction	Delete the sweep list pair
Parameter Type	Integer
Parameter Range	1 to the full count of the sweep list.
Return	None
Default	None
Menu	SWEEP > List Sweep > Delete
Example	:SWEep:LIST:DELeTe 1

3.5.3.15 Sweep List Edit ([:SOURce]:SWEep:LIST:CHANGe)

Command Format	[:SOURce]:SWEep:LIST:CHANGe <row>,<freq>,<power>,<time>
Instruction	Edit sweep list pair value
Parameter Type	Row: Integer, Freq: Float, unit: Hz, kHz, MHz, GHz, Power: Float, unit: dBm, dBmV, dBuV, V, W, Default: dBm, Time: Float, unit: ns, us, ms, s, Default "s"
Parameter Range	Raw: 1 ~ count of pair. Freq: Full frequency range. Power: Full level range. time: 10 ms ~ 100 s.
Return	None
Default	None
Menu	SWEEP > List Sweep
Example	:SWEep:LIST:CHANGe 1,1 GHz,1 dBm, 1 s

3.5.3.16 Sweep List Row Count ([:SOURce]:SWEep:LIST:CPOint?)

Command Format	[:SOURce]:SWEep:LIST:CPOint?
Instruction	Get how many rows in sweep list
Parameter Type	None
Parameter Range	None
Return	Float
Default	1
Menu	SWEEP > List Sweep
Example	:SWEep:LIST:CPOint?

3.5.3.17 Show Sweep List ([:SOURce]:SWEep:LIST:LIST?)

Command Format	[:SOURce]:SWEep:LIST:LIST? <begin_row>,<end_row>
Instruction	View starting row to end row data
Parameter Type	Integer, Integer
Parameter Range	1 to count of sweep list.
Return	String
Default	None
Menu	SWEEP > List Sweep
Example	:SWEep:LIST:LIST? 1,3

3.5.3.18 Sweep List Clear ([:SOURce]:SWEep:LIST:INITialize:PRESet)

Command Format	[:SOURce]:SWEep:LIST:INITialize:PRESet
Instruction	Restore the scan list of the factory default settings
Parameter Type	None
Parameter Range	None
Return	None
Default	None

Menu	SWEEP > List Sweep > Clear
Example	SWEEp:LIST:INITialize:PRESet

3.5.3.19 Sweep List Initialize From Step ([:SOURce]:SWEep:LIST:INITialize:FSTep)

Command Format	[:SOURce]:SWEep:LIST:INITialize:FSTep
Instruction	Regenerate the sweep list based on the data points of the current step sweep settings
Parameter Type	None
Parameter Range	None
Return	None
Default	None
Menu	SWEEP > List Sweep > Import
Example	SWEEp:LIST:INITialize:FSTep

3.5.3.20 Sweep List Load ([:SOURce]:SWEep:LOAD)

Command Format	[:SOURce]:CORRection:LOAD <file_name>
Instruction	Load existing sweep list file
Parameter Type	String
Parameter Range	None
Return	None
Default	None
Menu	SWEEP > List Sweep > Load
Example	:SWEep:LOAD "U-disk3/test.lsw"

3.5.3.21 Sweep List Store ([:SOURce]:SWEep:STORE)

Command Format	[:SOURce]:CORRection:STORE <file_name>
Instruction	Save the sweep data in the list
Parameter Type	String

Parameter Range	None
Return	None
Default	None
Menu	SWEEP > List Sweep > Save
Example	:SWEep:STORe "U-disk3/test.lsw"

3.5.3.22 Sweep Direction ([:SOURce]:SWEep:DIRect)

Command Format	[:SOURce]:SWEep:DIRect FWD REV [:SOURce]:SWEep:DIRect?
Instruction	Select the direction for sweep
Parameter Type	Enumeration
Parameter Range	FWD REV
Return	Enumeration
Default	FWD
Menu	SWEEP > Direction
Example	:SWEep:DIRect REV :SWEep:DIRect?

3.5.3.23 Sweep Mode ([:SOURce]:SWEep:MODE)

Command Format	[:SOURce]:SWEep:MODE CONTInue SINGle [:SOURce]:SWEep:MODE?
Instruction	Set the cycle mode of the sweep Get the cycle mode of the sweep
Parameter Type	Enumeration
Parameter Range	CONTInue SINGle
Return	Enumeration
Default	CONTInue
Menu	SWEEP > Sweep Mode

Example	:SWEep:MODE SINGle :SWEep:MODE?
----------------	------------------------------------

3.5.3.24 Execute Single Sweep ([:SOURce]:SWEep:EXECute)

Command Format	[:SOURce]:SWEep:EXECute
Instruction	Execute one single sweep when the sweep mode is Single.
Parameter Type	None
Parameter Range	None
Return	None
Default	None
Menu	SWEEP > Execute single sweep
Example	:SWEep:EXECute

3.5.3.25 Trigger Mode ([:SOURce]:SWEep:SWEep:TRIGger:TYPE)

Command Format	[:SOURce]:SWEep:SWEep:TRIGger:TYPE AUTO KEY BUS EXT [:SOURce]:SWEep:SWEep:TRIGger:TYPE?
Instruction	Select the trigger mode Get the trigger mode
Parameter Type	Enumeration
Parameter Range	AUTO KEY BUS EXT
Return	Enumeration
Default	AUTO
Menu	SWEEP > Trigger Mode
Example	:SWEep:SWEep:TRIGger:TYPE KEY :SWEep:SWEep:TRIGger:TYPE?

3.5.3.26 Point Trigger ([:SOURce]:SWEep:POINt:TRIGger:TYPE)

Command Format	[:SOURce]:SWEep:POINt:TRIGger:TYPE AUTO KEY BUS EXT [:SOURce]:SWEep:POINt:TRIGger:TYPE?
Instruction	Select the point trigger Get the point trigger
Parameter Type	Enumeration
Parameter Range	AUTO KEY BUS EXT
Return	Enumeration
Default	AUTO
Menu	SWEEP > Point Trigger
Example	:SWEep:POINt:TRIGger:TYPE KEY :SWEep:POINt:TRIGger:TYPE?

3.5.3.27 Bus Trigger ([:SOURce]:*TRG)

Command Format	[:SOURce]:*TRG
Instruction	When the trigger mode or point trigger mode is Bus, send this command to make the signal source start sweeping.
Parameter Type	None
Parameter Range	None
Return	None
Default	None
Menu	None
Example	*TRG

3.5.3.28 Trigger Slope ([:SOURce]:INPut:TRIGger:SLOPe)

Command Format	[:SOURce]:INPut:TRIGger:SLOPe POSitive NEGative [:SOURce]:INPut:TRIGger:SLOPe?
Instruction	Select the trigger slope when the trigger mode or point trigger is EXT.

	Get the trigger slope when the trigger mode or point trigger is EXT.
Parameter Type	Enumeration
Parameter Range	POSitive NEGative
Return	Enumeration
Default	POSitive
Menu	SWEEP > Trigger Slope
Example	:INPut:TRIGger:SLOPe NEGative :INPut:TRIGger:SLOPe?

3.5.3.29 Get Sweep Point ([:SOURce]:SWEep:CURRent:Data?)

Command Format	[:SOURce]:SWEep:CURRent:Data?
Instruction	Get the currently sweep point. The format is: index,{freq,level,time}
Parameter Type	None
Parameter Range	None
Return	String Index: interger freq: Hz level: dBm time: s
Default	None
Menu	None
Example	:SWEep:CURRent:Data? Return: 1,{1e+09,-5,0.03}

3.5.4 [:SOURce]:MODulation Subsystem

3.5.4.1 Modulation State ([:SOURce]:MODulation)

Command Format	[:SOURce]:MODulation ON OFF 1 0 [:SOURce]:MODulation?
Instruction	Switch modulation on and off Get the modulation state
Parameter Type	Boolean
Parameter Range	ON OFF 1 0
Return	Boolean
Default	0
Menu	MOD
Example	MODulation ON :MODulation?

3.5.4.2 Modulation State (:OUTPut:MODulation[:STATe])

Command Format	:OUTPut:MODulation[:STATe] ON OFF 1 0 :OUTPut:MODulation[:STATe]?
Instruction	Switch modulation on and off Get the modulation state
Parameter Type	Boolean
Parameter Range	ON OFF 1 0
Return	Boolean
Default	0
Menu	MOD
Example	:OUTPut:MODulation ON :OUTPut:MODulation?

3.5.5 [:SOURce]:AM Subsystem

3.5.5.1 AM State (:SOURce):AM:STATe)

Command Format	[:SOURce]:AM:STATe ON OFF 1 0 [:SOURce]:AM:STATe?
Instruction	Activate/Deactivate amplitude modulation (AM) Get the AM state
Parameter Type	Boolean
Parameter Range	ON OFF 1 0
Return	Boolean
Default	0
Menu	AM > AM State
Example	:AM:STATe ON :AM:STATe?

3.5.5.2 AM Shape (:SOURce):AM:WAVEform)

Command Format	[:SOURce]:AM:WAVEform SINE SQUAre [:SOURce]:AM:WAVEform?
Instruction	Set the AM modulation waveform Get the AM modulation waveform
Parameter Type	Enumeration
Parameter Range	SINE SQUAre
Return	Enumeration
Default	SINE
Menu	AM > AM Shape
Example	:AM:WAVEform SINE :AM:WAVEform?

3.5.5.3 AM Source ([:SOURce]:AM:SOURce)

Command Format	[:SOURce]:AM:SOURce INTernal EXTernal INT,EXT [:SOURce]:AM:SOURce?
Instruction	Select the modulation signal source for amplitude modulation Get the AM source
Parameter Type	Enumeration
Parameter Range	INTernal EXTernal INT,EXT
Return	Enumeration
Default	INTernal
Menu	AM > AM Source
Example	:AM:SOURce EXTernal :AM:SOURce?

3.5.5.4 AM Depth ([:SOURce]:AM:DEPTH)

Command Format	[:SOURce]:AM:DEPTH <value> [:SOURce]:AM:DEPTH?
Instruction	Set the overall modulation depth of the amplitude modulation in percent Get the AM depth
Parameter Type	Float
Parameter Range	0.1 % ~ 100 %
Return	Float
Default	50 %
Menu	AM > AM Depth
Example	:AM:DEPTH 0.2 :AM:DEPTH?

3.5.5.5 AM Rate ([:SOURce]:AM:FREQUENCY)

Command Format	[:SOURce]:AM:FREQUENCY <value> [:SOURce]:AM:FREQUENCY?
Instruction	Set the AM modulation frequency Get the AM modulation frequency
Parameter Type	Float, unit: Hz, kHz, MHz, GHz, Default "Hz"
Parameter Range	Sine: 0.01 Hz ~ 100 kHz Square: 0.01 Hz ~ 20 kHz
Return	Float, unit: Hz
Default	1 kHz
Menu	AM > AM Rate
Example	:AM:FREQUENCY 10 kHz :AM:FREQUENCY?

3.5.5.6 AM Sensitivity ([:SOURce]:AM:SENSitivity?)

Command Format	[:SOURce]:AM:SENSitivity?
Instruction	Query the input sensitivity of the external modulation input in /V
Parameter Type	None
Parameter Range	None
Return	Float, unit: /V
Default	0 %/V
Menu	AM > AM Sensitivity
Example	AM:SENSitivity?

3.5.6 [:SOURce]:FM Subsystem

3.5.6.1 FM State (:SOURce):FM:STATe)

Command Format	[:SOURce]:FM:STATe ON OFF 1 0 [:SOURce]:FM:STATe?
Instruction	Activate/Deactivate frequency modulation (FM) Get the FM state
Parameter Type	Boolean
Parameter Range	ON OFF 1 0
Return	Boolean
Default	0
Menu	FM > FM State
Example	:FM:STATe ON :FM:STATe?

3.5.6.2 FM Source (:SOURce):FM:SOURce)

Command Format	[:SOURce]:FM:SOURce INT1 INT2 INT1,INT2 EXTErnal INT1,EXT DUAL [:SOURce]:FM:SOURce?
Instruction	Select the modulation signal source for frequency modulation (FM) Get the FM Source
Parameter Type	Enumeration
Parameter Range	INT1 INT2 INT1,INT2 EXTErnal INT1,EXT DUAL
Return	Enumeration
Default	INTernal
Menu	FM > FM Source
Example	:FM:SOURce EXTErnal :FM:SOURce?

3.5.6.3 FM Shape1 ([:SOURce]:FM1:WAVEform)

Command Format	[:SOURce]:FM1:WAVEform SINE SQUAre SAWTooth TRIangle [:SOURce]:FM1:WAVEform?
Instruction	Selects the shape of the FM waveform1 when the FM Source includes Int1. Get the shape of the FM waveform1 when the FM Source includes Int1.
Parameter Type	Enumeration
Parameter Range	SINE SQUAre SAWTooth TRIangle
Return	Enumeration
Default	SINE
Menu	FM > FM Shape1
Example	:FM1:WAVEform SQUAre :FM1:WAVEform?

3.5.6.4 FM Deviation1 ([:SOURce]:FM1:DEViation)

Command Format	[:SOURce]:FM1:DEViation <value> [:SOURce]:FM1:DEViation?
Instruction	Set the deviation value of the FM waveform1 when the FM Source includes Int1. Get the deviation value of the FM waveform1 when the FM Source includes Int1.
Parameter Type	Float, unit: Hz, kHz, MHz, GHz
Parameter Range	1 Hz ~ N*1 MHz The Value of N please refer to SSG5000A datasheet.
Return	Float, unit: Hz
Default	100 kHz
Menu	FM > FM Deviation1
Example	:FM1:DEViation 500 kHz :FM1:DEViation?

3.5.6.5 FM Rate1 ([:SOURce]:FM1:FREQuency)

Command Format	[:SOURce]:FM1:FREQuency <value> [:SOURce]:FM1:FREQuency?
Instruction	Set the modulation frequency of the FM waveform1 when the FM Source includes Int1. Get the modulation frequency of the FM waveform1 when the FM Source includes Int1.
Parameter Type	Float, unit: Hz, kHz, MHz, GHz, Default "Hz"
Parameter Range	SQUAre SAWTooth TRiangle: 0.01 Hz ~ 20 kHz SINE: 0.01 Hz ~ 100 kHz
Return	Float, unit: Hz
Default	10 kHz
Menu	FM > FM Rate1
Example	:FM1:FREQuency 40 kHz :FM1:FREQuency?

3.5.6.6 FM Phase1 ([:SOURce]:FM1:PHASe)

Command Format	[:SOURce]:FM1:PHASe <value> [:SOURce]:FM1:PHASe?
Instruction	Set the phase of the FM waveform1 when the FM Source is Int1+Int2 or Dual. Get the phase of the FM waveform1 when the FM Source is Int1+Int2 or Dual.
Parameter Type	Float, unit: deg or rad, Default "deg"
Parameter Range	-360° ~ +360°
Return	Float, unit: deg
Default	0
Menu	FM > FM Phase1
Example	:FM1:PHASe -30 deg :FM1:PHASe?

3.5.6.7 FM Shape2 ([:SOURce]:FM2:WAVEform)

Command Format	[:SOURce]:FM2:WAVEform SINE SQUAre SAWTooth TRIangle [:SOURce]:FM2:WAVEform?
Instruction	Selects the shape of the FM waveform2 when the FM Source includes Int2. Get the shape of the FM waveform2 when the FM Source includes Int2.
Parameter Type	Enumeration
Parameter Range	SINE SQUAre SAWTooth TRIangle
Return	Enumeration
Default	SINE
Menu	FM > FM Shape2
Example	:FM2:WAVEform SAWTooth :FM2:WAVEform?

3.5.6.8 FM Deviation2 ([:SOURce]:FM2:DEViation)

Command Format	[:SOURce]:FM2:DEViation <value> [:SOURce]:FM2:DEViation?
Instruction	Set the deviation value of the FM waveform2 when the FM Source includes Int2. Get the deviation value of the FM waveform2 when the FM Source includes Int2.
Parameter Type	Float, unit: Hz, kHz, MHz, GHz
Parameter Range	1 Hz ~ N*1 MHz The Value of N please refer to SSG5000A datasheet.
Return	Float, unit: Hz
Default	100 kHz
Menu	FM > FM Deviation2
Example	:FM2:DEViation 600 kHz :FM2:DEViation?

3.5.6.9 FM Rate2 ([:SOURce]:FM2:FREQuency)

Command Format	[:SOURce]:FM2:FREQuency <value> [:SOURce]:FM2:FREQuency?
Instruction	Set the modulation frequency of the FM waveform2 when the FM Source includes Int2. Get the modulation frequency of the FM waveform2 when the FM Source includes Int2.
Parameter Type	Float, unit: Hz, kHz, MHz, GHz, Default "Hz"
Parameter Range	SQUAre SAWTooth TRiangle: 0.01 Hz ~ 20 kHz SINE: 0.01 Hz ~ 100 kHz
Return	Float, unit: Hz
Default	10 kHz
Menu	FM > FM Rate2
Example	:FM2:FREQuency 15 kHz :FM2:FREQuency?

3.5.6.10 FM Phase2 ([:SOURce]:FM2:PHASe)

Command Format	[:SOURce]:FM2:PHASe <value> [:SOURce]:FM2:PHASe?
Instruction	Set the phase of the FM waveform2 when the FM Source is Int1+Int2 or Dual. Get the phase of the FM waveform2 when the FM Source is Int1+Int2 or Dual.
Parameter Type	Float, unit: deg or rad, Default "deg"
Parameter Range	-360° ~ +360°
Return	Float, unit: deg
Default	0
Menu	FM > FM Phase2
Example	:FM2:PHASe 45 deg :FM2:PHASe?

3.5.6.11 Int1 Proportion ([:SOURce]:FM1:PROPortion)

Command Format	[:SOURce]:FM1:PROPortion <value> [:SOURce]:FM1:PROPortion?
Instruction	Set the proportion of the FM waveform1 when the FM Source is Dual. Get the proportion of the FM waveform1 when the FM Source is Dual.
Parameter Type	Float
Parameter Range	0 ~ 100%
Return	Float
Default	50%
Menu	FM > Int1 Proportion
Example	:FM1:PROPortion 0.6 :FM1:PROPortion?

3.5.6.12 FM Sensitivity1 ([:SOURce]:FM1:SENSitivity?)

Command Format	[:SOURce]:FM1:SENSitivity?
Instruction	Displays the input sensitivity of the FM EXT input in Hz/V when the FM Source includes Ext.
Parameter Type	None
Parameter Range	None
Return	Float unit: Hz/V
Default	0 Hz/V
Menu	FM > FM Sensitivity1
Example	FM1:SENSitivity?

3.5.7 [:SOURce]:PM Subsystem

3.5.7.1 PM State ([:SOURce]:PM:STATe)

Command Format	[:SOURce]:PM:STATe ON OFF 1 0 [:SOURce]:PM:STATe?
Instruction	Activate/Deactivate phase modulation (PM) Get the PM state
Parameter Type	Boolean
Parameter Range	ON OFF 1 0
Return	Boolean
Default	0
Menu	PM > PM State
Example	:PM:STATe ON :PM:STATe?

3.5.7.2 PM Shape ([:SOURce]:PM:WAVEform)

Command Format	[:SOURce]:PM:WAVEform SINE SQUAre [:SOURce]:PM:WAVEform?
Instruction	Selects the shape of PM Get the shape of PM
Parameter Type	Enumeration
Parameter Range	SINE SQUAre
Return	Enumeration
Default	SINE
Menu	PM > PM Shape
Example	:PM:WAVEform SINE :PM:WAVEform?

3.5.7.3 PM Source ([:SOURce]:PM:SOURce)

Command Format	[:SOURce]:PM:SOURce INTernal EXTernal INT,EXT [:SOURce]:PM:SOURce?
Instruction	Select the modulation signal source for phase modulation (PM) Get the PM source
Parameter Type	Enumeration
Parameter Range	INTernal EXTernal INT,EXT
Return	Enumeration
Default	INTernal
Menu	PM > PM Source
Example	:PM:SOURce EXTernal :PM:SOURce?

3.5.7.4 PM Deviation ([:SOURce]:PM:DEViation)

Command Format	[:SOURce]:PM:DEViation <value> [:SOURce]:PM:DEViation?
Instruction	Set the modulation deviation of the phase modulation (PM) Get the modulation deviation of the phase modulation (PM)
Parameter Type	Float, unit: rad
Parameter Range	0.01 rad ~ N*5 rad The value of N please refer to SSG5000A datasheet.
Return	Float, unit: rad
Default	1 rad
Menu	PM > PM Deviation
Example	:PM:DEViation 2 :PM:DEViation?

3.5.7.5 PM Rate ([:SOURce]:PM:FREQuency)

Command Format	[:SOURce]:PM:FREQuency <value> [:SOURce]:PM:FREQuency?
Instruction	Set the phase modulation (PM) frequency Get the phase modulation (PM) frequency
Parameter Type	Float, unit: Hz, kHz, MHz, GHz, Default "Hz"
Parameter Range	INTernal: SQUAre: 0.01 Hz ~ 20 kHz, SINE: 0.01 Hz ~ 100 kHz INT+EXT: SQUAre: 0.01 Hz ~ 20 kHz, SINE: 0.01 Hz ~ 100 kHz
Return	Float, unit: Hz
Default	10 kHz
Menu	PM > PM Rate
Example	:PM:FREQuency 10 kHz :PM:FREQuency?

3.5.7.6 PM Sensitivity ([:SOURce]:PM:SENSitivity?)

Command Format	[:SOURce]:PM:SENSitivity?
Instruction	Query the input sensitivity of the EXT MOD input in rad/v
Parameter Type	None
Parameter Range	None
Return	Float, unit: rad/V
Default	0 rad/V
Menu	PM > PM Sensitivity
Example	PM:SENSitivity?

3.5.8 [:SOURce]:PULM Subsystem

3.5.8.1 Pulse State (:SOURce):PULM:STATe)

Command Format	[:SOURce]:PULM:STATe ON OFF 1 0 [:SOURce]:PULM:STATe?
Instruction	Activate/Deactivate the pulse modulation Get the state of pulse modulation
Parameter Type	Boolean
Parameter Range	ON OFF 1 0
Return	Boolean
Default	0
Menu	PULSE > Pulse State
Example	PULM:STAT ON :PULM:STATe?

3.5.8.2 Pulse Out (:SOURce):PULM:OUT:STATe)

Command Format	[:SOURce]:PULM:OUT:STATe ON OFF 1 0 [:SOURce]:PULM:OUT:STATe?
Instruction	Configures the signal at the PULSE OUT connector Get the Pulse Output status
Parameter Type	Boolean
Parameter Range	ON OFF 1 0
Return	Boolean
Default	0
Menu	PULSE > Pulse Out
Example	PULM:OUT:STATe ON :PULM:OUT:STATe?

3.5.8.3 Pulse Source ([:SOURce]:PULM:SOURce)

Command Format	[:SOURce]:PULM:SOURce INTernal EXTernal [:SOURce]:PULM:SOURce?
Instruction	Select the source for the pulse modulation signal Get the source for the pulse modulation signal
Parameter Type	Enumeration
Parameter Range	INTernal EXTernal
Return	Enumeration
Default	INTernal
Menu	PULSE > Pulse Source
Example	PULM:SOUR INTernal :PULM:SOURce?

3.5.8.4 Pulse Source ([:SOURce]:PULM:SOURce:INT)

Command Format	[:SOURce]:PULM:SOURce:INT INTernal EXTernal [:SOURce]:PULM:SOURce:INT?
Instruction	Select the source for the pulse modulation signal Get the source for the pulse modulation signal
Parameter Type	Enumeration
Parameter Range	INTernal EXTernal
Return	Enumeration
Default	INTernal
Menu	PULSE > Pulse Source
Example	:PULM:SOURce:INT EXTernal :PULM:SOURce:INT?

3.5.8.5 Pulse Out Polarity ([:SOURce]:PULM:POLarity)

Command Format	[:SOURce]:PULM:POLarity NORMal INVerted [:SOURce]:PULM:POLarity?
Instruction	Set the period of the generated pulse. The period determines the repetition frequency of the internal signal Get the period of the generated pulse
Parameter Type	Enumeration
Parameter Range	NORMal INVerted
Return	Enumeration
Default	NORMal
Menu	PULSE > Pulse Out Polarity
Example	PULM:POL INV :PULM:POLarity?

3.5.8.6 Pulse Mode ([:SOURce]:PULM:MODE)

Command Format	[:SOURce]:PULM:MODE SINGle DOUBle PTRain [:SOURce]:PULM:MODE?
Instruction	Set the mode of the pulse generator Get the mode of the pulse generator
Parameter Type	Enumeration
Parameter Range	SINGle DOUBle PTRain SINGle Enables single pulse generation. DOUBle Enables double pulse generation. The two pulses are generated in one pulse period. PTRain A user-defined pulse train is generated. The pulse train is defined by value pairs of on and off times that can be entered in a pulse train list.
Return	Enumeration
Default	SINGle

Menu	PULSE > Pulse Mode
Example	PULM:MODE DOUB PULM:MODE?

3.5.8.7 Pulse Period ([:SOURce]:PULM:PERiod)

Command Format	[:SOURce]:PULM:PERiod <value> [:SOURce]:PULM:PERiod?
Instruction	Set the period of the generated pulse when pulse mode is Single or Double. The period determines the repetition frequency of the internal signal Get the period of the generated pulse
Parameter Type	Float, unit: ns, us, ms, s, and default is s.
Parameter Range	40 ns ~ 300 s
Return	Float, unit: s
Default	10 ms
Menu	PULSE > Pulse Period
Example	PULM:PER 220 us PULM:PER?

3.5.8.8 Pulse Period ([:SOURce]:PULM:INT[1]:PERiod)

Command Format	[:SOURce]:PULM:INT[1]:PERiod <value> [:SOURce]:PULM:INT[1]:PERiod?
Instruction	Set the period of the generated pulse when pulse mode is Single or Double. The period determines the repetition frequency of the internal signal Get the period of the generated pulse
Parameter Type	Float, unit: ns, us, ms, s, and default is s.
Parameter Range	40 ns ~ 300 s
Return	Float, unit: s
Default	10 ms

Menu	PULSE > Pulse Period
Example	:PULM:INT1:PERiod 900 ns :PULM:INT1:PERiod?

3.5.8.9 Pulse Width ([:SOURce]:PULM:WIDTH)

Command Format	[:SOURce]:PULM:WIDTH <value> [:SOURce]:PULM:WIDTH?
Instruction	Set the width of the generated pulse when pulse mode is Single or Double. Get the width of the generated pulse when pulse mode is Single or Double.
Parameter Type	Float, unit: ns, us, ms, s, and default is s.
Parameter Range	20 ns ~ 300 s
Return	Float, unit: s
Default	2 ms
Menu	PULSE > Pulse Width
Example	PULM:WIDT 33 us PULM:WIDT?

3.5.8.10 Pulse Width ([:SOURce]:PULM:INT[1]:PWIDth)

Command Format	[:SOURce]:PULM:INT[1]:PWIDth <value> [:SOURce]:PULM:INT[1]:PWIDth?
Instruction	Set the width of the generated pulse when pulse mode is Single or Double. Get the width of the generated pulse when pulse mode is Single or Double.
Parameter Type	Float, unit: ns, us, ms, s, and default is s.
Parameter Range	20 ns ~ 300 s
Return	Float, unit: s
Default	2 ms

Menu	PULSE > Pulse Width
Example	:PULM:INT:PWIDth 400 ns :PULM:INT:PWIDth?

3.5.8.11 Double Pulse Delay ([:SOURce]:PULM:DOUBle:DELay)

Command Format	[:SOURce]:PULM:DOUBle:DELay <value> [:SOURce]:PULM:DOUBle:DELay?
Instruction	Set the delay from the start of the first pulse to the start of the second pulse when pulse mode is Double. Get the delay from the start of the first pulse to the start of the second pulse when pulse mode is Double.
Parameter Type	Float, unit: ns, us, ms, s, and default is s.
Parameter Range	20 ns ~ 300 s
Return	Float, unit: s
Default	4 ms
Menu	PULSE > Double Pulse Delay
Example	:PULM:DOUBle:DELay 2 ms :PULM:DOUBle:DELay?

3.5.8.12 #2 Width ([:SOURce]:PULM:DOUBle:WIDTh)

Command Format	[:SOURce]:PULM:DOUBle:WIDTh <time> [:SOURce]:PULM:DOUBle:WIDTh?
Instruction	Set the width of the second pulse in the case of double pulse generation Get the width of the second pulse in the case of double pulse generation
Parameter Type	Float, unit: ns, us, ms, s, and default is s.
Parameter Range	20 ns ~ 300 s
Return	Float, unit: s
Default	2 ms
Menu	PULSE > #2 Width

Example	PULM:DOUBle:WIDTh 2 s PULM:DOUBle:WIDTh?
----------------	---

3.5.8.13 Pulse Train Add Row ([:SOURce]:PULM:TRAI:n:PAIR)

Command Format	[:SOURce]:PULM:TRAI:n:PAIR <row>
Instruction	Copy and paste the specified row in front of the specified row.
Parameter Type	Integer
Parameter Range	1 ~ N, which is the specified row number. N: the length of the current pulse train.
Return	None
Default	None
Menu	PULSE > Pulse Train > Add
Example	PULM:TRAI:n:PAIR 1

3.5.8.14 Pulse Train Delete ([:SOURce]:PULM:TRAI:n:DELeTe)

Command Format	[:SOURce]:PULM:TRAI:n:DELeTe <row>
Instruction	Delete the train pair
Parameter Type	Integer
Parameter Range	1 ~ N, which is the specified row number. N: the length of the current pulse train.
Return	None
Default	None
Menu	PULSE > Pulse Train > Delete
Example	PULM:TRAI:n:DELeTe 5

3.5.8.15 Pulse Train Edit On Time ([:SOURce]:PULM:TRAI:DATA:ONTIme)

Command Format	[:SOURce]:PULM:TRAI:DATA:ONTIme <raw>,<on_time>
Instruction	Edit train ontime value
Parameter Type	raw: integer, on_time: float, unit: ns, us, ms, s, and default is s.
Parameter Range	raw: 1 ~ count of pair, on_time: 20ns ~ 300s.
Return	None
Default	None
Menu	PULSE > Pulse Train
Example	:PULM:TRAI:DATA:ONTIme 1,10 ms

3.5.8.16 Pulse Train Edit Off Time ([:SOURce]:PULM:TRAI:DATA:OFFTime)

Command Format	[:SOURce]:PULM:TRAI:DATA:OFFTime <raw>,<off_time>
Instruction	Edit train off time value
Parameter Type	raw: integer, off_time: float, unit: ns, us, ms, s, and default is s.
Parameter Range	raw: 1 ~ count of pair, off_time: 20ns ~ 300s.
Return	None
Default	None
Menu	PULSE > Pulse Train
Example	:PULM:TRAI:DATA:OFFTime 1, 20 ms

3.5.8.17 Pulse Train Edit Count ([:SOURce]:PULM:TRAI:DATA:COUNT)

Command Format	[:SOURce]:PULM:TRAI:DATA:COUNT <raw>,<count>
Instruction	Edit train count value

Parameter Type	Integer, Integer
Parameter Range	Raw: 1 ~ count of pair. Count: 1 ~ 65535
Return	None
Default	None
Menu	PULSE > Pulse Train
Example	:PULM:TRAI:DATA:COUNT 1,3

3.5.8.18 Pulse Train Edit ([:SOURce]:PULM:TRAI:CHANGE)

Command Format	[:SOURce]:PULM:TRAI:CHANGE <row>,<on_time>,<off_time>,<count>
Instruction	Edit train pair value
Parameter Type	raw: integer, on_time: float, unit: ns, us, ms, s, and default is s, off_time: float, unit: ns, us, ms, s, and default is s, count: integer.
Parameter Range	raw: 1 ~ count of pair, on_time: 20ns ~ 300s, off_time: 20ns ~ 300s, count: 1 ~ 65535.
Return	None
Default	None
Menu	PULSE > Pulse Train
Example	:PULM:TRAI:CHANGE 2,3 ms,500 ns,4

3.5.8.19 List Pulse Train ([:SOURce]:PULM:TRAI:LIST?)

Command Format	[:SOURce]:PULM:TRAI:LIST? <begin_row>,<end_row>
Instruction	View starting row to end row data
Parameter Type	Integer, Integer

Parameter Range	Begin_row: 1 ~ the count of the pulse list End_row: Begin_row ~ the count of the pulse list
Return	String
Default	None
Menu	PULSE > Pulse Train
Example	:PULM:TRAI:LIST? 1,3

3.5.8.20 Pulse Train Count ([:SOURce]:PULM:TRAI:COUNT?)

Command Format	[:SOURce]:PULM:TRAI:COUNT?
Instruction	Get count of train list
Parameter Type	None
Parameter Range	None
Return	Integer
Default	1
Menu	PULSE > Pulse Train
Example	:PULM:TRAI:COUNT?

3.5.8.21 Pulse Train Clear ([:SOURce]:PULM:TRAI:CLEAr)

Command Format	[:SOURce]:PULM:TRAI:CLEAr
Instruction	Clear train pair list
Parameter Type	None
Parameter Range	None
Return	None
Default	None
Menu	PULSE > Pulse Train > Store
Example	PULM:TRAI:CLEAr

3.5.8.22 Pulse Train Load ([:SOURce]:PULM:TRAI:n:LOAD)

Command Format	[:SOURce]:PULM:TRAI:n:LOAD <file>
Instruction	Load train pair list
Parameter Type	String
Parameter Range	None
Return	None
Default	None
Menu	PULSE > Pulse Train > Load
Example	PULM:TRAI:n:LOAD "U-disk3/test.pulstrn"

3.5.8.23 Pulse Train Store ([:SOURce]:PULM:TRAI:n:STORE)

Command Format	[:SOURce]:PULM:TRAI:n:STORE <file>
Instruction	Store train pair list
Parameter Type	String
Parameter Range	None
Return	None
Default	None
Menu	PULSE > Pulse Train > Save
Example	PULM:TRAI:n:STORE "test.pulstrn" PULM:TRAI:n:STORE "U-disk1/test.pulstrn"

3.5.8.24 Trigger Out ([:SOURce]:PULM:TRIGger:STATe)

Command Format	[:SOURce]:PULM:TRIGger:STATe ON OFF 1 0 [:SOURce]:PULM:TRIGger:STATe?
Instruction	Set the trigger output status Get the trigger output status
Parameter Type	Boolean

Parameter Range	ON OFF 1 0
Return	Boolean
Default	1
Menu	PULSE > Trigger Out
Example	PULM:TRIGger:STATe ON :PULM:TRIGger:STATe?

3.5.8.25 Pulse Trigger ([:SOURce]:PULM:TRIGger:MODE)

Command Format	[:SOURce]:PULM:TRIGger:MODE AUTO KEY EXTErnal EGATE [:SOURce]:PULM:TRIGger:MODE?
Instruction	Select the trigger mode for pulse modulation Get the trigger mode for pulse modulation
Parameter Type	Enumeration
Parameter Range	AUTO KEY EXTErnal EGATE
Return	Enumeration
Default	AUTO
Menu	PULSE > Pulse Trigger
Example	PULM:TRIG:MODE EXTErnal :PULM:TRIGger:MODE?

3.5.8.26 Trig Polarity ([:SOURce]:PULM:TRIGger:EXTErnal:GATE:POLarity)

Command Format	[:SOURce]:PULM:TRIGger:EXTErnal:GATE:POLarity NORMal INVerted [:SOURce]:PULM:TRIGger:EXTErnal:GATE:POLarity?
Instruction	Select the polarity of the gate signal Get the polarity of the gate signal
Parameter Type	Enumeration
Parameter Range	NORMal INVerted
Return	Enumeration

Default	NORMAL
Menu	PULSE > Pulse Polarity
Example	PULM:TRIG:EXT:GATE:POL NORMAL :PULM:TRIGger:EXTernal:GATE:POLarity?

3.5.8.27 Trig Delay ([:SOURce]:PULM:DELay)

Command Format	[:SOURce]:PULM:DELay <value> [:SOURce]:PULM:DELay?
Instruction	Set the pulse delay Get the pulse delay
Parameter Type	Float, unit: ns, us, ms, s, and default is s.
Parameter Range	140 ns ~ 300 s
Return	Float, unit: s
Default	140 ns
Menu	PULSE > Trig Delay
Example	PULM:DEL 30 ms :PULM:DELay?

3.5.8.28 Trig Slope ([:SOURce]:PULM:TRIGger:EXTernal:SLOPe)

Command Format	[:SOURce]:PULM:TRIGger:EXTernal:SLOPe NEGative POSitive [:SOURce]:PULM:TRIGger:EXTernal:SLOPe?
Instruction	Set the polarity of the active slope of an applied trigger at the PULSE EXT connector Get the polarity of the active slope of an applied trigger at the PULSE EXT connector
Parameter Type	Enumeration
Parameter Range	NEGative POSitive
Return	Enumeration
Default	POSitive

Menu	PULSE > Trig Slope
Example	PULM:TRIG:EXT:SLOP NEG PULM:TRIG:EXT:SLOP?

3.5.9 [:SOURce]:LFOutput Subsystem

3.5.9.1 LF State ([:SOURce]:LFOutput)

Command Format	[:SOURce]:LFOutput ON OFF 1 0 [:SOURce]:LFOutput?
Instruction	Activate/deactivate the LF output Get the LF output state
Parameter Type	Boolean
Parameter Range	ON OFF 1 0
Return	Boolean
Default	0
Menu	LF > LF State
Example	LFOutput ON LFOutput?

3.5.9.2 LF Level ([:SOURce]:LFOutput:VOLTage)

Command Format	[:SOURce]:LFOutput:VOLTage <volt> [:SOURce]:LFOutput:VOLTage?
Instruction	Set the voltage of the LF output signal Get the voltage of the LF output signal
Parameter Type	Float, unit: dBm, uVpp, mVpp, Vpp, nW, uW, mW, Default: Vpp
Parameter Range	1 mVpp ~ 3 Vpp
Return	Float, unit: Vpp
Default	0.5 Vpp
Menu	LF > LF Voltage

Example	LFOutput:VOLTage 2 Vpp LFOutput:VOLTage?
----------------	---

3.5.9.3 LF Offset ([:SOURce]:LFOutput:OFFSEt)

Command Format	[:SOURce]:LFOutput:OFFSEt <volt> [:SOURce]:LFOutput:OFFSEt?
Instruction	Set the voltage offset of the LF output signal Get the voltage offset of the LF output signal
Parameter Type	Float, unit: dBm, uV, mV, V, nW, uW, mW, Default: V
Parameter Range	$ LFoffset \leq \min(2.5V - \frac{1}{2}LEVEL, 2V)$
Return	Float, unit: V
Default	0 V
Menu	LF > LF Offset
Example	LFOutput:OFFSEt 1 V LFOutput:OFFSEt?

3.5.9.4 LF Frequency ([:SOURce]:LFOutput:FREQuency)

Command Format	[:SOURce]:LFOutput:FREQuency <freq> [:SOURce]:LFOutput:FREQuency?
Instruction	Set LF out put frequency. Get LF out put frequency. If the signal source is set to "Internal", the instrument performs the analog modulations (AM/FM /PM) with this frequency.
Parameter Type	Float, unit: Hz, kHz, MHz, GHz, Default "Hz"
Parameter Range	0.01 Hz ~ 1 MHz
Return	Float, unit: Hz
Default	1 kHz
Menu	LF > LF Frequency

Example	LFOutput:FREQUENCY 10 kHz LFOutput:FREQUENCY?
----------------	--

3.5.9.5 LF Shape ([:SOURce]:LFOutput:SHAPE)

Command Format	[:SOURce]:LFOutput:SHAPE SINE SQUare TRIangle SAWTooth DC [:SOURce]:LFOutput:SHAPE?
Instruction	Select the shape of the LF signal Get the shape of the LF signal
Parameter Type	Enumeration
Parameter Range	SINE SQUare TRIangle SAWTooth DC
Return	Enumeration
Default	SINE
Menu	LF > LF Shape
Example	LFOutput:SHAPE TRIangle :LFOutput:SHAPE?

3.5.9.6 LF Phase ([:SOURce]:LFOutput:PHASE)

Command Format	[:SOURce]:LFOutput:PHASE <deg> [:SOURce]:LFOutput:PHASE?
Instruction	Set the phase of the LF output signal Get the phase of the LF output signal
Parameter Type	Float, unit: deg
Parameter Range	-360 deg ~ 360 deg
Return	Float, unit: deg
Default	0 deg
Menu	LF > LF Phase
Example	LFOutput:PHASE 20 LFOutput:PHASE?

3.5.10 [:SOURce]:LFOutput:SWEep Subsystem

3.5.10.1 Sweep State (:SOURce):LFOutput:SWEep)

Command Format	[:SOURce]:LFOutput:SWEep ON OFF 1 0 [:SOURce]:LFOutput:SWEep?
Instruction	Activate/Deactivate the LF frequency sweep signal generation Get the state of LF frequency sweep
Parameter Type	Boolean
Parameter Range	ON OFF 1 0
Return	Boolean
Default	0
Menu	LF Sweep > LF State
Example	:LFOutput:SWEep 1 :LFOutput:SWEep?

3.5.10.2 Sweep Direction (:SOURce):LFOutput:SWEep:DIRect)

Command Format	[:SOURce]:LFOutput:SWEep:DIRect UP DOWN [:SOURce]:LFOutput:SWEep:DIRect?
Instruction	Set the sweep direction Get the sweep direction
Parameter Type	Enumeration
Parameter Range	UP DOWN
Return	Enumeration
Default	UP
Menu	LF Sweep > Sweep Direction
Example	:LFOutput:SWEep:DIRect DOWN :LFOutput:SWEep:DIRect?

3.5.10.3 Start Freq ([:SOURce]:LFOutput:SWEep:STARt:FREQuency)

Command Format	[:SOURce]:LFOutput:SWEep:STARt:FREQuency <freq> [:SOURce]:LFOutput:SWEep:STARt:FREQuency?
Instruction	Set the start frequency of sweep mode Get the start frequency of sweep mode
Parameter Type	Float, unit: Hz, kHz, MHz, GHz, Default "Hz"
Parameter Range	0.01 Hz ~ Stop frequency
Return	Float, unit: Hz
Default	500 Hz
Menu	LF Sweep > Start Freq
Example	:LFOutput:SWEep:STARt:FREQuency 100 :LFOutput:SWEep:STARt:FREQuency?

3.5.10.4 Stop Freq ([:SOURce]:LFOutput:SWEep:STOP:FREQuency)

Command Format	[:SOURce]:LFOutput:SWEep:STOP:FREQuency <freq> [:SOURce]:LFOutput:SWEep:STOP:FREQuency?
Instruction	Set the stop frequency of sweep mode Get the stop frequency of sweep mode
Parameter Type	Float, unit: Hz, kHz, MHz, GHz, Default "Hz"
Parameter Range	Start frequency ~ Maximum frequency of LF
Return	Float, unit: Hz
Default	1.5 kHz
Menu	LF Sweep > Stop Freq
Example	:LFOutput:SWEep:STOP:FREQuency 1000 :LFOutput:SWEep:STOP:FREQuency?

3.5.10.5 Center Freq ([:SOURce]:LFOutput:SWEep:CENTer:FREQuency)

Command Format	[:SOURce]:LFOutput:SWEep:CENTer:FREQuency <freq> [:SOURce]:LFOutput:SWEep:CENTer:FREQuency?
Instruction	Set the center frequency of sweep mode Get the center frequency of sweep mode
Parameter Type	Float, unit: Hz, kHz, MHz, GHz, Default “Hz”
Parameter Range	0.01 Hz ~ Maximum frequency of LF
Return	Float, unit: Hz
Default	1 kHz
Menu	LF Sweep > Center Freq
Example	:LFOutput:SWEep:CENTer:FREQuency 550 :LFOutput:SWEep:CENTer:FREQuency?

3.5.10.6 Freq Span ([:SOURce]:LFOutput:SWEep:SPAN:FREQuency)

Command Format	[:SOURce]:LFOutput:SWEep:SPAN:FREQuency <freq> [:SOURce]:LFOutput:SWEep:SPAN:FREQuency?
Instruction	Set the center frequency of sweep mode Get the center frequency of sweep mode
Parameter Type	Float, unit: Hz, kHz, MHz, GHz, Default “Hz”
Parameter Range	0 Hz ~ Maximum frequency of LF – 0.01 Hz
Return	Float, unit: Hz
Default	1 kHz
Menu	LF Sweep > Freq Span
Example	:LFOutput:SWEep:SPAN:FREQuency 550 :LFOutput:SWEep:SPAN:FREQuency?

3.5.10.7 Sweep Time ([:SOURce]:LFOutput:SWEep:DWELI)

Command Format	[:SOURce]:LFOutput:SWEep:DWELI <time> [:SOURce]:LFOutput:SWEep:DWELI?
Instruction	Set the sweep time of sweep mode Get the sweep time of sweep mode
Parameter Type	Float, unit: ns, us, ms, s, and default is s.
Parameter Range	1 ms ~ 500 s
Return	Float, unit: s
Default	1 s
Menu	LF Sweep > Sweep Time
Example	:LFOutput:SWEep:DWELI 2 s :LFOutput:SWEep:DWELI?

3.5.10.8 Trigger Mode ([:SOURce]:LFOutput:SWEep:TRIGger:TYPE)

Command Format	[:SOURce]:LFOutput:SWEep:TRIGger:TYPE AUTO KEY BUS EXT [:SOURce]:LFOutput:SWEep:TRIGger:TYPE?
Instruction	Select the LF frequency sweep trigger mode Get the LF frequency sweep trigger mode
Parameter Type	Enumeration
Parameter Range	AUTO KEY BUS EXT
Return	Enumeration
Default	AUTO
Menu	LF Sweep > Trigger Mode
Example	:LFOutput:SWEep:TRIGger:TYPE KEY :LFOutput:SWEep:TRIGger:TYPE?

3.5.10.9 Trigger Slope ([:SOURce]:LFOutput:SWEep:XPOLar)

Command Format	[:SOURce]:LFOutput:SWEep:XPOLar POS NEG [:SOURce]:LFOutput:SWEep:XPOLar?
Instruction	Select the trigger slope of the external trigger signal Get the trigger slope of the external trigger signal
Parameter Type	Enumeration
Parameter Range	POS NEG
Return	Enumeration
Default	POS
Menu	LF Sweep > Trigger Slope
Example	:LFOutput:SWEep:XPOLar POS :LFOutput:SWEep:XPOLar?

3.5.10.10 Sweep Shape ([:SOURce]:LFOutput:SWEep:SHAPE)

Command Format	[:SOURce]:LFOutput:SWEep:SHAPE TRlangle SAWTooth [:SOURce]:LFOutput:SWEep:SHAPE?
Instruction	Select the waveform shape of the sweep signal Get the waveform shape of the sweep signal
Parameter Type	Enumeration
Parameter Range	TRlangle SAWTooth
Return	Enumeration
Default	SAWTooth
Menu	LF Sweep > Sweep Shape
Example	:LFOutput:SWEep:SHAPE TRlangle :LFOutput:SWEep:SHAPE?

3.5.10.11 Sweep Space ([:SOURce]:LFOutput:SWEep:SPACing)

Command Format	[:SOURce]:LFOutput:SWEep:SPACing LINear LOGarithmic [:SOURce]:LFOutput:SWEep:SPACing?
Instruction	Select the mode for the calculation of the frequency sweep intervals Get the mode for the calculation of the frequency sweep intervals
Parameter Type	Enumeration
Parameter Range	LINear LOGarithmic
Return	Enumeration
Default	LINear
Menu	LF Sweep > Sweep Space
Example	:LFOutput:SWEep:SPACing LOGarithmic :LFOutput:SWEep:SPACing?

3.6 Sense Subsystem

3.6.1 Sensor Info (:SENSe[:POWER]:TYPE?)

Command Format	:SENSe[:POWER]:TYPE?
Instruction	Query the type of sensor connected to the POWER SENSOR connector
Parameter Type	None
Parameter Range	None
Return	String
Default	None
Menu	SENSOR > Sensor Info
Example	SENSe:TYPE?

3.6.2 Sensor State (:SENSe[:POWer]:STATUs)

Command Format	:SENSe[:POWer]:STATUs OFF ON 0 1 :SENSe[:POWer]:STATUs?
Instruction	Set the sensor state Get the sensor state
Parameter Type	Boolean
Parameter Range	OFF ON 0 1
Return	Boolean
Default	0
Menu	SENSOR > Sensor State
Example	SENSe:STATUs ON SENSe:STATUs?

3.6.3 Measurement (:SENSe[:POWer]:VALue?)

Command Format	:SENSe[:POWer]:VALue?
Instruction	Indicate the current reading of the sensor
Parameter Type	None
Parameter Range	None
Return	Float, unit: dBm
Default	None
Menu	SENSOR > Measurement
Example	SENSe:VALue?

3.6.4 Statistics State (:SENSe[:POWer]:STATIStics:STATe)

Command Format	:SENSe[:POWer]:STATIStics:STATe ON OFF 1 0 :SENSe[:POWer]:STATIStics:STATe?
Instruction	Set statistical status of power meter readings Get statistical status of power meter readings

Parameter Type	Boolean
Parameter Range	ON OFF 1 0
Return	Boolean
Default	0
Menu	SENSOR > Statistics
Example	SENSe:STATIStics:STATe ON SENSe:STATIStics:STATe?

3.6.5 Statistics Value (:READ[:POWer]?)

Command Format	:READ[:POWer]?
Instruction	Indicate the measured mean value and maximum value of power meter readings
Parameter Type	None
Parameter Range	None
Return	String
Default	None
Menu	SENSOR > Statistics
Example	READ?

3.6.6 Statistics Max Value (:SENSe[:POWer]:STATIStics:MAX?)

Command Format	:SENSe[:POWer]:STATIStics:MAX?
Instruction	Indicate the measured maximum value of power meter readings
Parameter Type	None
Parameter Range	None
Return	Float, unit: dBm
Default	None
Menu	SENSOR > Statistics

Example	SENSe:STATIStics:MAX?
----------------	-----------------------

3.6.7 Statistics Min Value (:SENSe[:POWer]:STATIStics:MIN?)

Command Format	:SENSe[:POWer]:STATIStics:MIN?
Instruction	Indicate the measured minimum value of power meter readings
Parameter Type	None
Parameter Range	None
Return	Float, unit: dBm
Default	None
Menu	SENSOR > Statistics
Example	SENSe:STATIStics:MIN?

3.6.8 Statistics Mean Value (:SENSe[:POWer]:STATIStics:AVG?)

Command Format	:SENSe[:POWer]:STATIStics:AVG?
Instruction	Indicate the measured mean value of power meter readings
Parameter Type	None
Parameter Range	None
Return	Float, unit: dBm
Default	None
Menu	SENSOR > Statistics
Example	SENSe:STATIStics:AVG?

3.6.9 Statistics Count (:SENSe[:POWer]:STATIStics:COUNT?)

Command Format	:SENSe[:POWer]:STATIStics:COUNT?
Instruction	Indicate the number of measurements being used to calculate the statistics

Parameter Type	None
Parameter Range	None
Return	Integer
Default	None
Menu	SENSOR > Statistics
Example	SENSE:STATISTICS:COUNT?

3.6.10 Statistics Clear (:SENSE[:POWER]:STATISTICS:CLEAr)

Command Format	:SENSE[:POWER]:STATISTICS:CLEAr
Instruction	Clear the statistics counter of power meter
Parameter Type	None
Parameter Range	None
Return	None
Default	None
Menu	SENSOR > Statistics
Example	SENSE:STATISTICS:CLEAr

3.6.11 Auto Zero (:CALibration:ZERO:TYPE)

Command Format	:CALibration:ZERO:TYPE INTERNAL EXTERNAL :CALibration:ZERO:TYPE?
Instruction	Select zero type of power meter Get zero type of power meter
Parameter Type	Enumeration
Parameter Range	INTERNAL EXTERNAL
Return	Enumeration
Default	INTERNAL
Menu	SENSOR > Auto Zero

Example	CALibration:ZERO:TYPE EXTernal :CALibration:ZERO:TYPE?
----------------	---

3.6.12 Zeroing (:SENSe[:POWer]:ZERO)

Command Format	:SENSe[:POWer]:ZERO
Instruction	Perform zeroing of the sensor
Parameter Type	None
Parameter Range	None
Return	None
Default	None
Menu	SENSOR > Click to perform zeroing
Example	:SENSe:ZERO

3.6.13 Frequency Type (:SENSe[:POWer]:SOURce)

Command Format	:SENSe[:POWer]:SOURce RF USER :SENSe[:POWer]:SOURce?
Instruction	Select the signal source for the measurement Get the signal source for the measurement
Parameter Type	Enumeration
Parameter Range	RF USER
Return	Enumeration
Default	RF
Menu	SENSOR > Frequency
Example	SENSe:SOURce RF SENSe:SOURce?

3.6.14 Frequency (:SENSe[:POWer]:FREQUency)

Command Format	:SENSe[:POWer]:FREQUency <freq> :SENSe[:POWer]:FREQUency?
Instruction	Set the frequency for frequency type "USER" Get the frequency for frequency type "USER"
Parameter Type	Float, unit: Hz, kHz, MHz, GHz, Default "Hz"
Parameter Range	9 kHz ~ Full frequency range
Return	Float, unit: Hz
Default	None
Menu	SENSOR > Frequency
Example	SENSe:FREQUency 1 MHz SENSe:FREQUency?

3.6.15 Level Offset State (:SENSe[:POWer]:OFFSet:STATe)

Command Format	:SENSe[:POWer]:OFFSet:STATe ON OFF 1 0 :SENSe[:POWer]:OFFSet:STATe?
Instruction	Switch the power offset switch status Get the power offset switch status
Parameter Type	Boolean
Parameter Range	ON OFF 1 0
Return	Boolean
Default	0
Menu	SENSOR > Level Offset
Example	SENSe:OFFSet:STATe ON SENSe:OFFSet:STATe?

3.6.16 Level Offset (:SENSe[:POWer]:OFFSet)

Command Format	:SENSe[:POWer]:OFFSet <power> :SENSe[:POWer]:OFFSet?
Instruction	The command enters a level offset which is mathematically added to the measured level value Get the level offset which is mathematically added to the measured level value
Parameter Type	Float, unit: dB
Parameter Range	Limit by power sensor.
Return	Float, unit: dB
Default	0 dB
Menu	SENSOR > Level Offset
Example	SENSe:OFFSet 10 SENSe:OFFSet?

3.6.17 Average Type (:SENSe[:POWer]:FILTer:TYPE)

Command Format	:SENSe[:POWer]:FILTer:TYPE AUTO USER NSRatio :SENSe[:POWer]:FILTer:TYPE?
Instruction	Select the averaging mode Get the averaging mode
Parameter Type	Enumeration
Parameter Range	AUTO USER NSRatio
Return	Enumeration
Default	AUTO
Menu	SENSOR > Averaging
Example	SENSe:FILTer:TYPE USER SENSe:FILTer:TYPE?

3.6.18 Average Times (:SENSe[:POWer]:FILTer:LENGth)

Command Format	:SENSe[:POWer]:FILTer:LENGth <length> :SENSe[:POWer]:FILTer:LENGth?
Instruction	Set the average number times
Parameter Type	Integer
Parameter Range	Limit by power sensor
Return	Float
Default	None
Menu	SENSOR > Averaging
Example	SENSe:FILTer:LENGth 10 SENSe:FILTer:LENGth?

3.6.19 Internal Noise (:SENSe[:POWer]:FILTer:NSRatio)

Command Format	:SENSe[:POWer]:FILTer:NSRatio <noise> :SENSe[:POWer]:FILTer:NSRatio?
Instruction	The power sensor will control the internal noise that does not exceed the set value of the fixed noise parameter
Parameter Type	Float, unit: dB
Parameter Range	Limit by power sensor.
Return	Float, unit: dB
Default	None
Menu	SENSOR > Averaging
Example	SENSe:FILTer:NSRatio 1 SENSe:FILTer:NSRatio?

3.6.20 Logging (:SENSe[:POWer]:LOGGing:STATe)

Command Format	:SENSe[:POWer]:LOGGing:STATe <state> :SENSe[:POWer]:LOGGing:STATe?
Instruction	Set logging state Get logging state
Parameter Type	Boolean
Parameter Range	ON OFF 1 0
Return	Boolean
Default	0
Menu	SENSOR > Logging
Example	SENSe:LOGGing:STATe ON SENSe:LOGGing:STATe?

4 Programming Examples

This chapter gives some examples for the programmer. In these examples you can see how to use the VISA or sockets, in combination with the commands have been described above to control the signal generator. By following these examples, you can develop many more applications.

4.1 VISA Examples

4.1.1 VC++ Example

Environment: Win10 64bit system, Visual Studio

The functions of this example: Use National Instruments NI-VISA to control the device with USBTMC or TCP/IP access and perform write and read operations.

Follow the steps to finish the example:

1. Open Visual Studio, create a new VC++ win32 console project.
2. Set the project environment to use the NI-VISA lib, there are two ways to use NI-VISA, static or automatic:

(1) Static: find files: visa.h, visatype.h, visa32.lib in NI-VISA install path. Copy them to your project, and add them into project. In the projectname.cpp file, add the follow two lines:

```
#include "visa.h"  
  
#pragma comment(lib, "visa32.lib")
```

(2) Automatic:

Set the .h file include directory, the NI-VISA install path, in our computer we set the path is: C:\Program Files\IVI Foundation\IVISA\WinNT\include. Set this path to project---properties---c/c++---General---Additional Include Directories: See the picture:

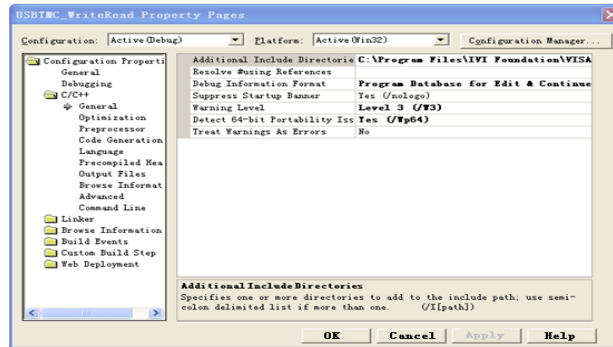

Set lib path set lib file:

Set lib path: the NI-VISA install path, in our computer we set the path is: C:\Program Files\IVI Foundation\... Set this path to project---properties---Linker---General---Additional Library Directories: as seen in the pictures below.

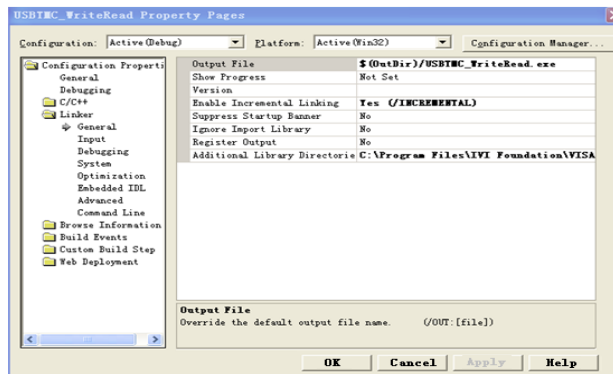

Set lib file: project---properties---Linker---Command Line---Additional Options: visa32.lib

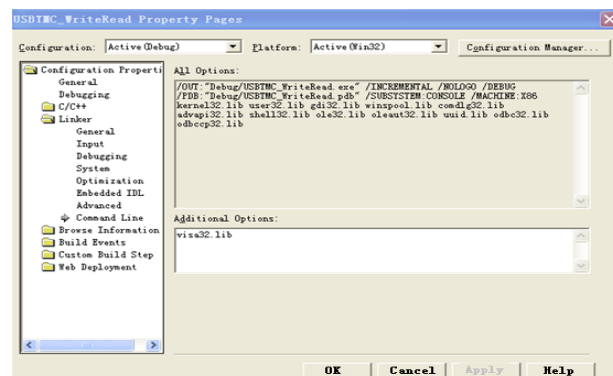

Include visa.h file: In the projectname.cpp file:

```
#include <visa.h>
```

3. Add the following code:

(1) USBTMC access code.

Write a function Usbtmc_test:

```
int Usbtmc_test()
{
    /* This code demonstrates sending synchronous read & write commands */
    /* to an USB Test & Measurement Class (USBTMC) instrument using */
    /* NI-VISA */
    /* The example writes the "*IDN?\n" string to all the USBTMC */
    /* devices connected to the system and attempts to read back */
    /* results using the write and read functions. */
    /* The general flow of the code is */
    /* Open Resource Manager */
    /* Open VISA Session to an Instrument */
    /* Write the Identification Query Using viPrintf */
    /* Try to Read a Response With viScanf */
    /* Close the VISA Session */

    /*******/

    ViSession defaultRM;
    ViSession instr;
    ViUInt32 numInstrs;
    ViFindList findList;
    ViStatus status;

    char instrResourceString[VI_FIND_BUFLLEN];
    unsigned char buffer[100];
    int i;

    /** First we must call viOpenDefaultRM to get the manager
```

```
* handle. We will store this handle in defaultRM.*/
status = viOpenDefaultRM (&defaultRM);
if (status<VI_SUCCESS)
{
printf ("Could not open a session to the VISA Resource Manager!\n");
returnstatus;
}
/* Find all the USB TMC VISA resources in our system and store the number of resources in the
system in numInstrs.*/
status = viFindRsrc (defaultRM, "USB?*INSTR", &findList, &numInstrs, instrResourceString);
if (status<VI_SUCCESS)
{
printf ("An error occurred while finding resources.\nPress 'Enter' to continue.");
fflush(stdin);
getchar();
viClose (defaultRM);
returnstatus;
}
/** Now we will open VISA sessions to all USB TMC instruments.
* We must use the handle from viOpenDefaultRM and we must
* also use a string that indicates which instrument to open. This
* is called the instrument descriptor. The format for this string
* can be found in the function panel by right clicking on the
* descriptor parameter. After opening a session to the
* device, we will get a handle to the instrument which we
* will use in later VISA functions. The AccessMode and Timeout
* parameters in this function are reserved for future
* functionality. These two parameters are given the value VI_NULL.*/
for (i=0; i<int(numInstrs); i++)
```



```
{
if (i> 0)
{
viFindNext (findList, instrResourceString);
}
status = viOpen (defaultRM, instrResourceString, VI_NULL, VI_NULL, &instr);
if (status<VI_SUCCESS)
{
printf ("Cannot open a session to the device %d.\n", i+1);
continue ;
}
/* * At this point we now have a session open to the USB TMC instrument.
* We will now use the viPrintf function to send the device the string "**IDN?\n",
* asking for the device's identification. */
char * cmmand ="**IDN?\n";
status = viPrintf (instr, cmmand);
if (status<VI_SUCCESS)
{
printf ("Error writing to the device %d.\n", i+1);
status = viClose (instr);
continue;
}
/** Now we will attempt to read back a response from the device to
* the identification query that was sent. We will use the viScanf
* function to acquire the data.
* After the data has been read the response is displayed. */
status = viScanf(instr, "%t", buffer);
if (status<VI_SUCCESS)
{
```

```

printf ("Error reading a response from the device %d.\n", i+1);
}
else
{
printf ("\nDevice %d: %s\n", i+1, buffer);
}
status = viClose (instr);
}
/** Now we will close the session to the instrument using
 * viClose. This operation frees all system resources. */
status = viClose (defaultRM);
printf("Press 'Enter' to exit.");
fflush(stdin);
getchar();
return 0;
}

int _tmain(int argc, _TCHAR* argv[])
{
Usbtmc_test();
return 0;
}

```

The run result:

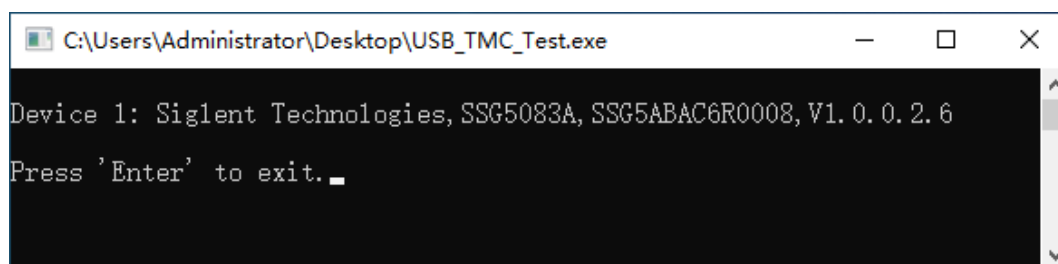

```

C:\Users\Administrator\Desktop\USB_TMC_Test.exe
Device 1: Siglent Technologies, SSG5083A, SSG5ABAC6R0008, V1. 0. 0. 2. 6
Press 'Enter' to exit.

```

(2) TCP/IP access code.

Write a function TCP_IP_Test:

```
int TCP_IP_Test(char *pIP)
{
    char outputBuffer[VI_FIND_BUFLEN];
    ViSession defaultRM, instr;
    ViStatus status;

    /* First we will need to open the default resource manager. */
    status = viOpenDefaultRM (&defaultRM);
    if (status<VI_SUCCESS)
    {
        printf("Could not open a session to the VISA Resource Manager!\n");
    }
    /* Now we will open a session via TCP/IP device */
    char head[256] = "TCPIP0::";
    char tail[] = "::INSTR";

    strcat(head,pIP);
    strcat(head,tail);
    status = viOpen (defaultRM, head, VI_LOAD_CONFIG, VI_NULL, &instr);
    if (status<VI_SUCCESS)
    {
        printf ("An error occurred opening the session\n");
        viClose(defaultRM);
    }
    status = viPrintf(instr, "**idn?\n");
    if (status<VI_SUCCESS)
```

```
{
printf("Error writing to the device.\n");
viClose(defaultRM);
}
status = viScanf(instr, "%t", outputBuffer);
if (status<VI_SUCCESS)
{
printf("viRead failed with error code: %x \n",status);
viClose(defaultRM);
}
else
{
printf ("\nMesseage read from device: %*s\n", 0,outputBuffer);
}
status = viClose (instr);
status = viClose (defaultRM);
printf("Press 'Enter' to exit.");
fflush(stdin);
getchar();
return 0;
}
```

```
int _tmain(int argc, _TCHAR* argv[])
{
printf("Please input IP address:");
char ip[256];
fflush(stdin);
gets(ip);
TCP_IP_Test(ip);
```

```
return 0;
}
```

The run result:

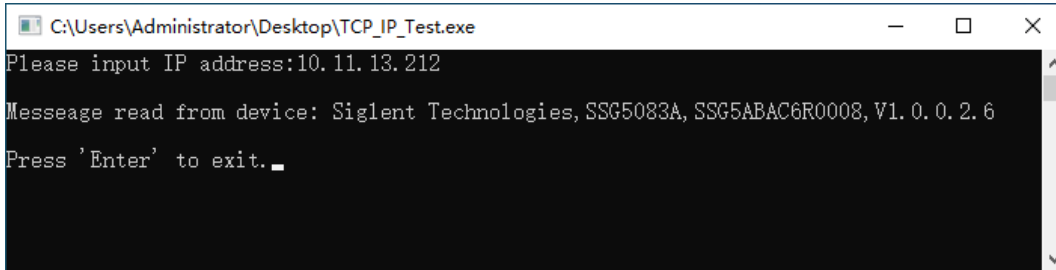

4.1.2 VB Example

Environment: Win10 64bit system, Microsoft Visual Basic 6.0

The function of this example: Use National Instruments NI-VISA to control the device with USBTMC and TCP/IP access and perform write and read operations.

Follow the steps to complete the example:

1. Open Visual Basic, build a standard application program project (Standard EXE)
2. Set the project environment to use the NI-VISA lib, Click the Existing tab of Project>>Add Existing Item. Search for the visa32.bas file in the include folder under the NI-VISA installation path and add the file.

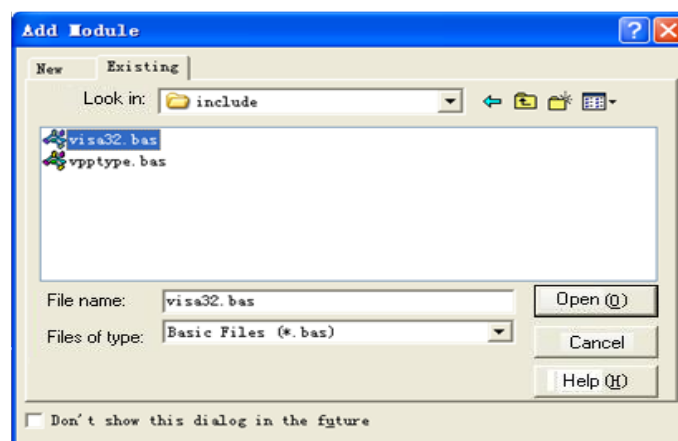

This allows the VISA functions and VISA data types to be used in a program.

3. Add the following code:

(1) USBTMC access code.

Write a function Usbtmc_test:

```
Private Function Usbtmc_test() As Long
```

```
' This code demonstrates sending synchronous read & write commands  
' to an USB Test & Measurement Class (USBTMC) instrument using  
' NI-VISA  
' The example writes the "*IDN?\n" string to all the USBTMC  
' devices connected to the system and attempts to read back  
' results using the write and read functions.  
' The general flow of the code is  
' Open Resource Manager  
' Open VISA Session to an Instrument  
' Write the Identification Query Using viWrite  
' Try to Read a Response With viRead  
' Close the VISA Session
```

```
Const MAX_CNT = 200
```

```
Dim defaultRM As Long
```

```
Dim instrsesn As Long
```

```
Dim numInstrs As Long
```

```
Dim findList As Long
```

```
Dim retCount As Long
```

```
Dim status As Long
```

```

Dim instrResourceString As String * VI_FIND_BUFLEN

Dim Buffer As String * MAX_CNT

Dim i As Integer

' First we must call viOpenDefaultRM to get the manager
' handle. We will store this handle in defaultRM.
status = viOpenDefaultRM(defaultRM)

If (status < VI_SUCCESS) Then

    resultTxt.Text = "Could not open a session to the VISA Resource Manager!"

    Usbtmc_test = status

    Exit Function

End If

' Find all the USB TMC VISA resources in our system and store the
' number of resources in the system in numInstrs.
status = viFindRsrc(defaultRM, "USB?*INSTR", findList, numInstrs, instrResourceString)

If (status < VI_SUCCESS) Then

    resultTxt.Text = "An error occurred while finding resources."

    viClose(defaultRM)

    Usbtmc_test = status

    Exit Function

End If

' Now we will open VISA sessions to all USB TMC instruments.
' We must use the handle from viOpenDefaultRM and we must
' also use a string that indicates which instrument to open. This
' is called the instrument descriptor. The format for this string
' can be found in the function panel by right clicking on the
' descriptor parameter. After opening a session to the
' device, we will get a handle to the instrument which we

```

' will use in later VISA functions. The AccessMode and Timeout
' parameters in this function are reserved for future
' functionality. These two parameters are given the value VI_NULL.

For i = 0 To numInstrs

 If (i > 0) Then

 status = viFindNext(findList, instrResourceString)

 End If

 status = viOpen(defaultRM, instrResourceString, VI_NULL, VI_NULL, instrsesn)

 If (status < VI_SUCCESS) Then

 resultTxt.Text = "Cannot open a session to the device " + CStr(i + 1)

 GoTo NextFind

 End If

' At this point we now have a session open to the USB TMC instrument.

' We will now use the viWrite function to send the device the string "*IDN?",

' asking for the device's identification.

 status = viWrite(instrsesn, "*IDN?", 5, retCount)

 If (status < VI_SUCCESS) Then

 resultTxt.Text = "Error writing to the device."

 status = viClose(instrsesn)

 GoTo NextFind

 End If

' Now we will attempt to read back a response from the device to

' the identification query that was sent. We will use the viRead

' function to acquire the data.

' After the data has been read the response is displayed.

 status = viRead(instrsesn, Buffer, MAX_CNT, retCount)

 If (status < VI_SUCCESS) Then

```
resultTxt.Text = "Error reading a response from the device." + CStr(i + 1)
```

```
Else
```

```
resultTxt.Text = "Read from device: " + CStr(i + 1) + " " + Buffer
```

```
End If
```

```
status = viClose(instrsesn)
```

```
Next i
```

```
' Now we will close the session to the instrument using
```

```
' viClose. This operation frees all system resources.
```

```
status = viClose(defaultRM)
```

```
Usbtmc_test = 0
```

```
End Function
```

(2) TCP/IP access code.

Write a function TCP_IP_Test:

```
Private Function TCP_IP_Test(ByVal ip As String) As Long
```

```
Dim outputBuffer As String * VI_FIND_BUFLen
```

```
Dim defaultRM As Long
```

```
Dim instrsesn As Long
```

```
Dim status As Long
```

```
Dim count As Long
```

```
' First we will need to open the default resource manager.
```

```
status = viOpenDefaultRM(defaultRM)
```

```
If (status < VI_SUCCESS) Then
```

```
resultTxt.Text = "Could not open a session to the VISA Resource Manager!"
```

```
TCP_IP_Test = status
```

Exit Function

End If

' Now we will open a session via TCP/IP device

```
status = viOpen(defaultRM, "TCPIP0::" + ip + "::INSTR", VI_LOAD_CONFIG, VI_NULL, instrsesn)
```

```
If (status < VI_SUCCESS) Then
```

```
    resultTxt.Text = "An error occurred opening the session"
```

```
    viClose(defaultRM)
```

```
    TCP_IP_Test = status
```

```
    Exit Function
```

```
End If
```

```
status = viWrite(instrsesn, "*IDN?", 5, count)
```

```
If (status < VI_SUCCESS) Then
```

```
    resultTxt.Text = "Error writing to the device."
```

```
End If
```

```
status = viRead(instrsesn, outputBuffer, VI_FIND_BUFLEN, count)
```

```
If (status < VI_SUCCESS) Then
```

```
    resultTxt.Text = "Error reading a response from the device." + CStr(i + 1)
```

```
Else
```

```
    resultTxt.Text = "read from device:" + outputBuffer
```

```
End If
```

```
status = viClose(instrsesn)
```

```
status = viClose(defaultRM)
```

```
TCP_IP_Test = 0
```

```
End Function
```

(3) Button control code:

```
Private Sub exitBtn_Click()  
    End  
End Sub  
Private Sub tcpipBtn_Click()  
    Dim stat As Long  
    stat = TCP_IP_Test(ipTxt.Text)  
    If (stat < VI_SUCCESS) Then  
        resultTxt.Text = Hex(stat)  
    End If  
End Sub  
Private Sub usbBtn_Click()  
    Dim stat As Long  
    stat = Usbtmc_test  
    If (stat < VI_SUCCESS) Then  
        resultTxt.Text = Hex(stat)  
    End If  
End Sub
```

The run result:

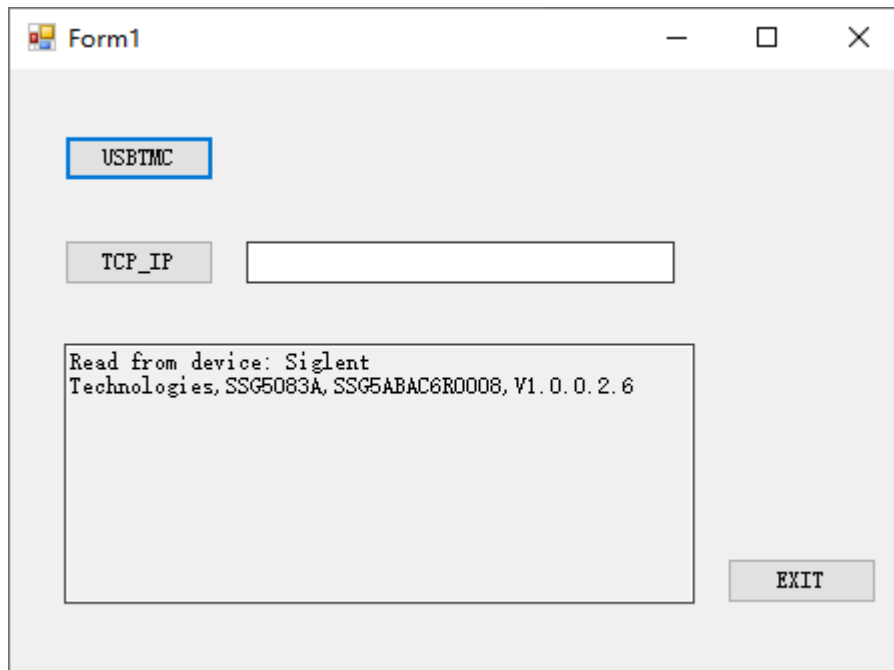

Form1

USBTMC

TCP_IP

```
Read from device: Siglent  
Technologies, SSG5083A, SSG5ABAC6R0008, V1.0.0.2.6
```

EXIT

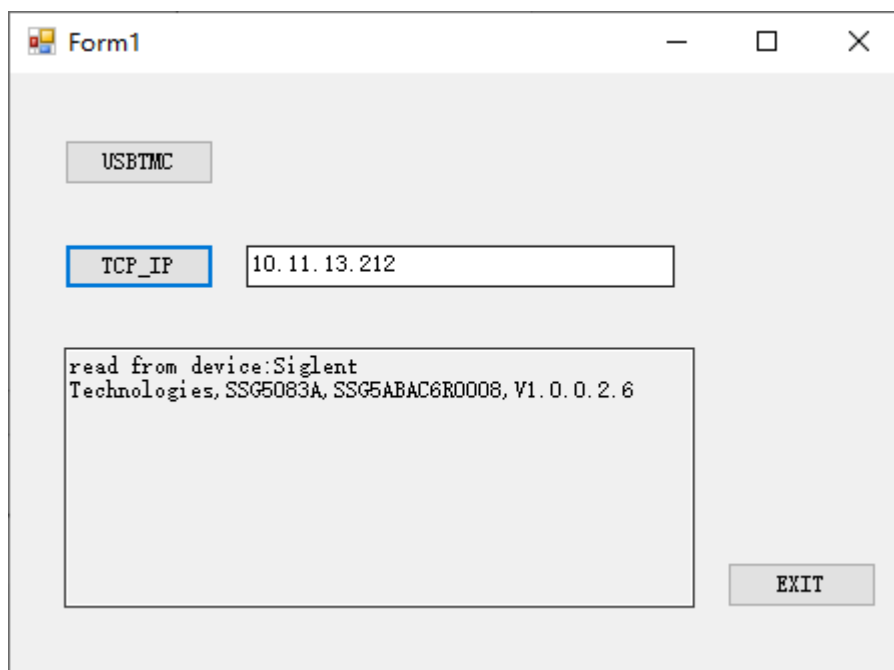

Form1

USBTMC

TCP_IP 10.11.13.212

```
read from device:Siglent  
Technologies, SSG5083A, SSG5ABAC6R0008, V1.0.0.2.6
```

EXIT

4.1.3 MATLAB Example

Environment: Win10 64bit system, MATLAB R2021a

The function of this example: Use National Instruments NI-VISA to control the device with USBTMC or TCP/IP access and perform write and read operations.

Follow the steps to complete the example:

1. Open MATLAB, modify the **current directory**. In this demo, the current directory is modified to D:\USBTMC_TCPIP_Demo.
2. Click **File>>New>>Script** in the Matlab interface to create an empty M file
3. Add codes:

(1) USBTMC access code

Write a function Usbtmc_test.

```
function USBTMC_test()
% This code demonstrates sending synchronous read & write commands
% to an USB Test & Measurement Class (USBTMC) instrument using
% NI-VISA

%Create a VISA-USB object connected to a USB instrument
vu = visa('ni','USB0::0xF4EC::0x1503::SSG5ABAC6R0008::INSTR');

%Open the VISA object created
fopen(vu);
```

%Send the string "*IDN?",asking for the device's identification.

```
fprintf(vu, '*IDN?');
```

%Request the data

```
outputbuffer = fscanf(vu);
```

```
disp(outputbuffer);
```

%Close the VISA object

```
fclose(vu);
```

```
delete(vu);
```

```
clear vu;
```

```
end
```

The run result:

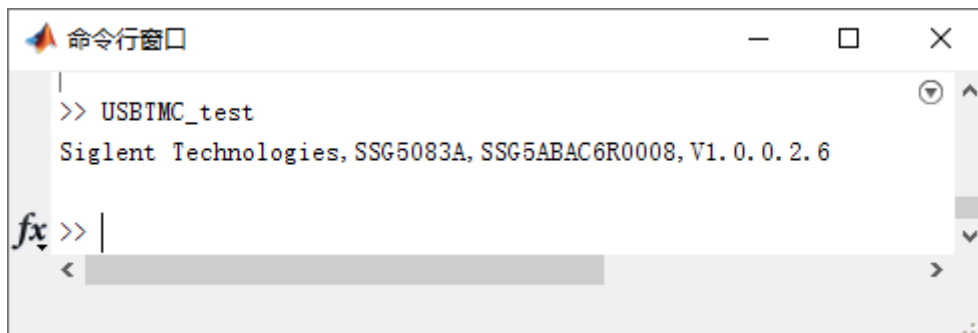

```
命令行窗口
|
| >> USBTMC_test
| Siglent Technologies, SSG5083A, SSG5ABAC6R0008, V1.0.0.2.6
fx >> |
| < |
```

(2) TCP/IP access code.

Write a function TCP_IP_Test:

```
function TCP_IP_test()
```

% This code demonstrates sending synchronous read & write commands

% to an TCP/IP instrument using NI-VISA

%Create a VISA-TCPIP object connected to an instrument

%configured with IP address.

```
vt = visa('ni',['TCPIP0::','10.11.13.212','::INSTR']);
```

%Open the VISA object created

```
fopen(vt);
```

%Send the string "*IDN?",asking for the device's identification.

```
fprintf(vt,'*IDN?');
```

%Request the data

```
outputbuffer = fscanf(vt);
```

```
disp(outputbuffer);
```

%Close the VISA object

```
fclose(vt);
```

```
delete(vt);
```

```
clear vt;
```

```
end
```

The run result:

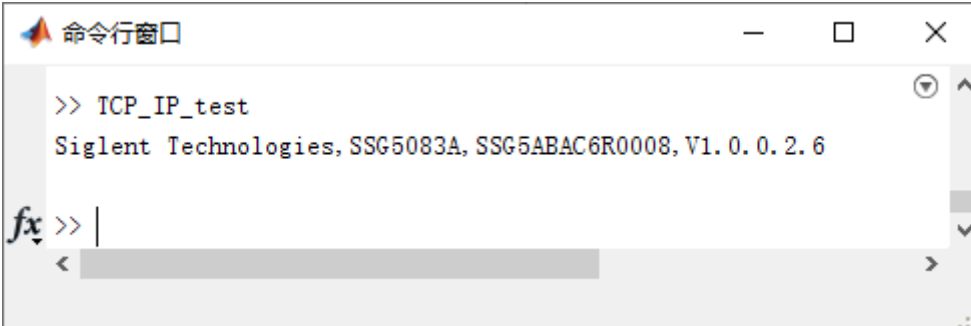

```

命令行窗口
>> ICP_IP_test
Siglent Technologies, SSG5083A, SSG5ABAC6R0008, V1.0.0.2.6
fx >> |

```

4.1.4 LabVIEW Example

Environment: Win7 32bit system, LabVIEW 2011

The functions of this example: Use National Instruments NI-VISA to control the device with USBTMC and TCP/IP access to perform write and read operations.

Follow the steps to complete the example:

1. Open LabVIEW, create a VI file.
2. Add controls. Right-click in the **Front Panel** interface, select and add **VISA resource name**, error in, error out and some indicators from the Controls column.
3. Open the **Block Diagram** interface. Right-click on the **VISA resource name** and you can select and add the following functions from VISA Palette from the pop-up menu: **VISA Write**, **VISA Read**, **VISA Open** and **VISA Close**.
4. Connect them as shown in the figure below

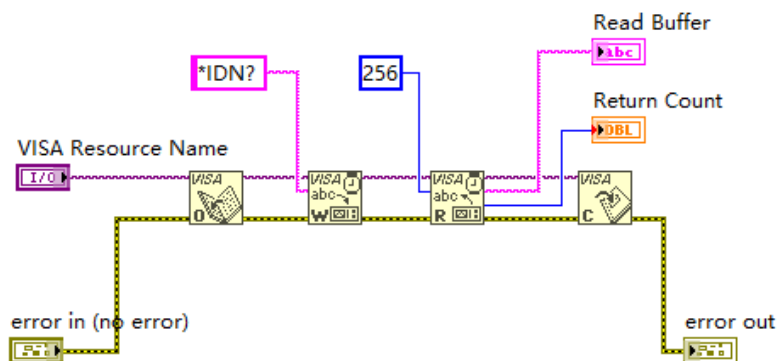

5. Select the device resource from the VISA Resource Name list box and run the program.

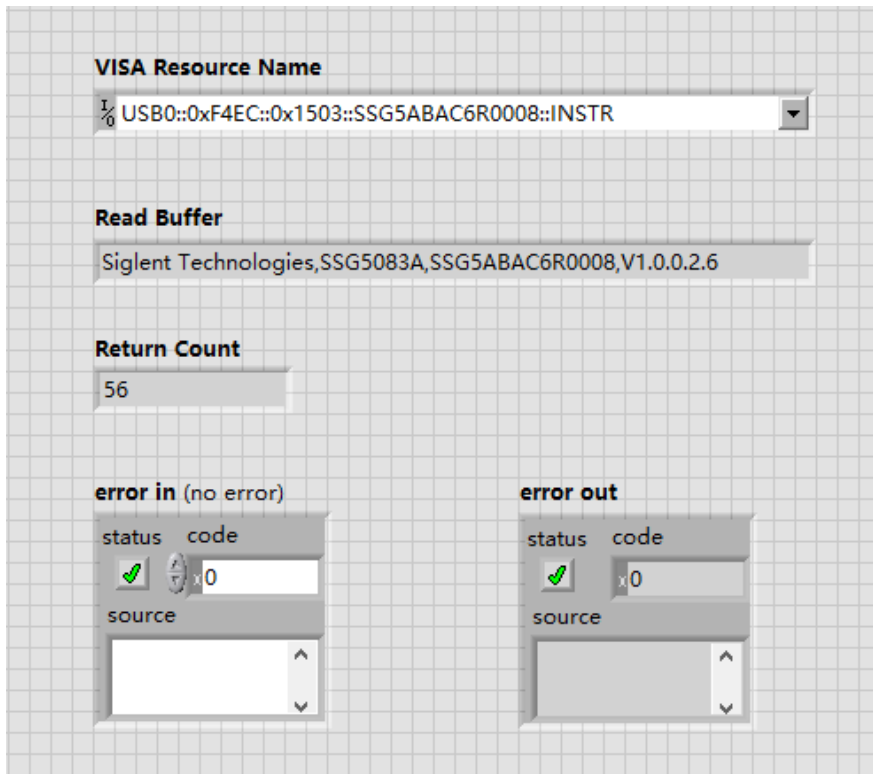

In this example, the VI opens a VISA session to a USBTMC device, writes a command to the device, and reads back the response. In this example, the specific command being sent is the device ID query. Check with your device manufacturer for the device command set. After all communication is complete, the VI closes the VISA session.

6. Communicating with the device via TCP/IP is similar to USBTMC. But you need to change VISA Write and VISA Read Function to Synchronous I/O. The LabVIEW default is asynchronous I/O. Right-click the node and select Synchronous I/O Mod>>Synchronous from the shortcut menu to write or read data synchronously.
7. Connect them as shown in the figure below

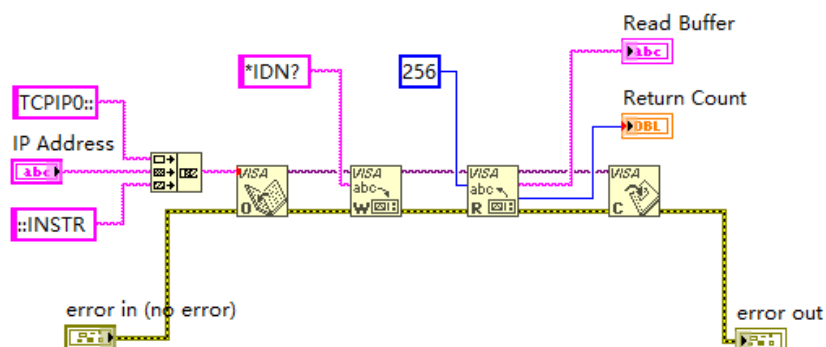

8. Input the IP address and run the program.

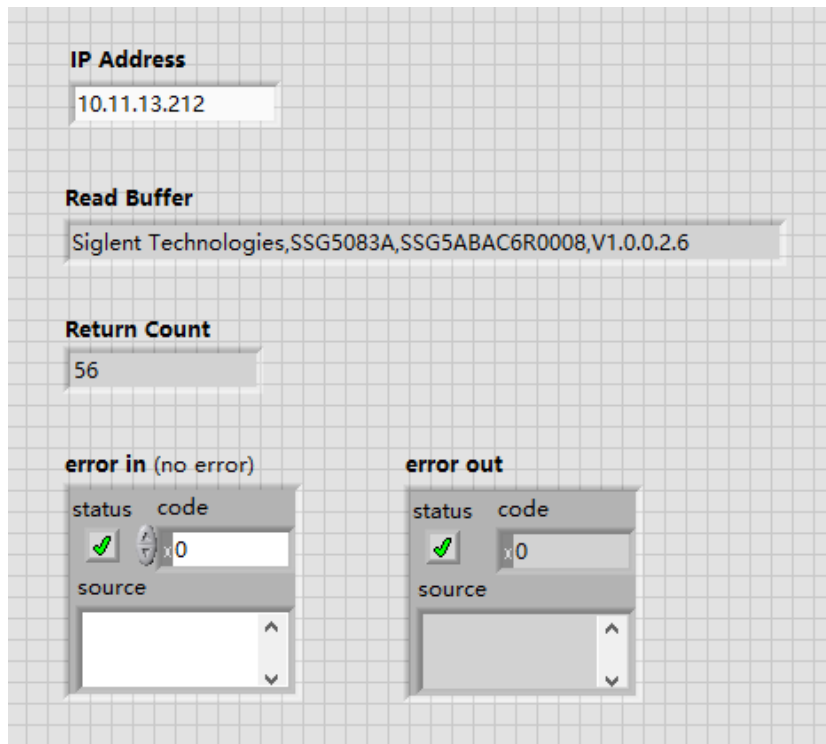

4.2 Socket Examples

4.2.1 Python Example

Python is an interpreted programming language that lets you work quickly and is very portable. Python has a low-level networking module that provides access to the socket interface. Python scripts can be written for sockets to do a variety of test and measurements tasks.

Environment: Win10 64bit system, Python v3.6.5

The functions of this example: Opens a socket, sends a query, and closes the socket. It does this loop 10 times.

Below is the code of the script:

```
#!/usr/bin/env python
#-*- coding:utf-8 -*-
```

```
#-----  
# The short script is an example that open a socket, sends a query,  
# print the return message and closes the socket.  
#-----  
import socket # for sockets  
import sys # for exit  
import time # for sleep  
#-----  
remote_ip = "10.11.13.32" # should match the instrument's IP address  
port = 5025 # the port number of the instrument service  
  
def SocketConnect():  
    try:  
        #create an AF_INET, STREAM socket (TCP)  
        s = socket.socket(socket.AF_INET, socket.SOCK_STREAM)  
    except socket.error:  
input ('Failed to create socket. \nPress "Enter" to exit: ' )  
        sys.exit()  
    try:  
        #Connect to remote server  
        s.connect((remote_ip , port))  
    except socket.error:  
        input('Failed to connect to ip %s!\nPress "Enter" to exit: ' % remote_ip)  
        s.close()  
        sys.exit()  
    return s  
  
def SocketQuery(Sock, cmd):  
    try :
```

```
#Send cmd string
Sock.sendall(cmd)
time.sleep(1)
except socket.error:
    #Send failed
input('Send failed!\nPress "Enter" to exit: ')
SocketClose(Sock)
    sys.exit()
reply = Sock.recv(4096)
reply = reply.decode()
    return reply

def SocketClose(Sock):
    #close the socket
    Sock.close()
    time.sleep(.300)

def main():
    # Body: send the SCPI commands *IDN? 10 times and print the return message
s = SocketConnect()

count = 0
for i in range(10):
    qStr = SocketQuery(s, b'*IDN?\n')
    print (str(count) + " :: " + qStr)
    count = count + 1
SocketClose(s)
input('Press "Enter" to exit')
```

```
if __name__ == '__main__':
    main()
```

The run result:

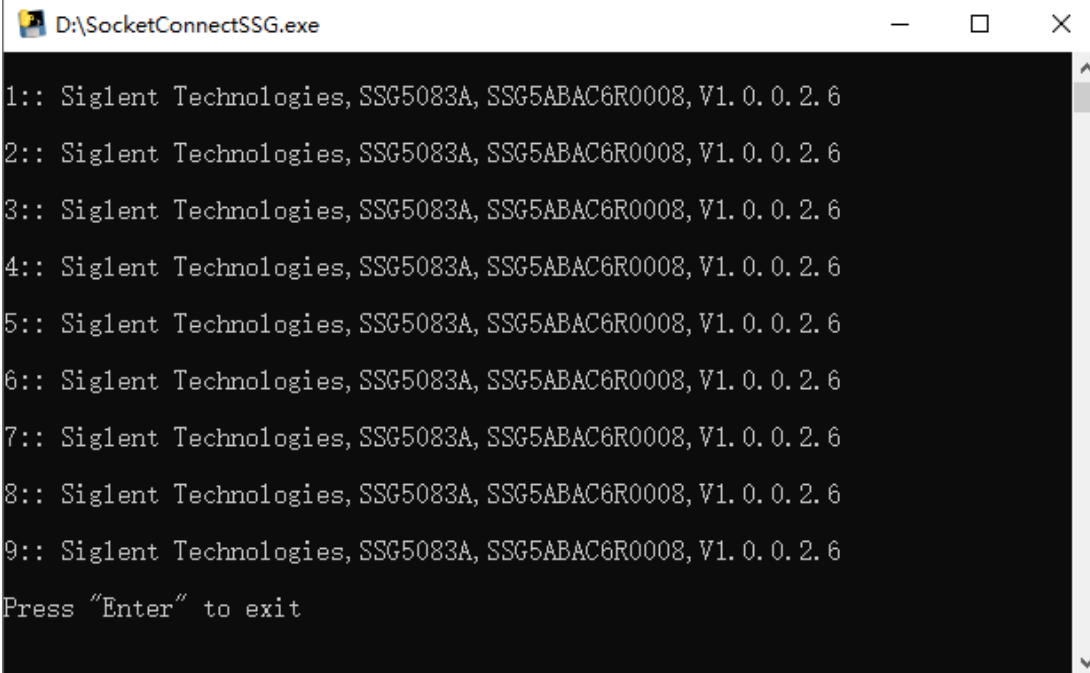

```
D:\SocketConnectSSG.exe
1:: Siglent Technologies, SSG5083A, SSG5ABAC6R0008, V1.0.0.2.6
2:: Siglent Technologies, SSG5083A, SSG5ABAC6R0008, V1.0.0.2.6
3:: Siglent Technologies, SSG5083A, SSG5ABAC6R0008, V1.0.0.2.6
4:: Siglent Technologies, SSG5083A, SSG5ABAC6R0008, V1.0.0.2.6
5:: Siglent Technologies, SSG5083A, SSG5ABAC6R0008, V1.0.0.2.6
6:: Siglent Technologies, SSG5083A, SSG5ABAC6R0008, V1.0.0.2.6
7:: Siglent Technologies, SSG5083A, SSG5ABAC6R0008, V1.0.0.2.6
8:: Siglent Technologies, SSG5083A, SSG5ABAC6R0008, V1.0.0.2.6
9:: Siglent Technologies, SSG5083A, SSG5ABAC6R0008, V1.0.0.2.6
Press "Enter" to exit
```

4.2.2 Telnet Example

Telnet SCPI: Provides the ability to send single SCPI commands from a remote PC to the signal generator using LAN port number 5024.

How to send single SCPI commands using Telnet:

1. On the remote PC, click Start, then Run cmd
2. Type: **telnet <ip address> 5024**
3. A Telnet window with a **>>** prompt should appear on the remote PC screen.

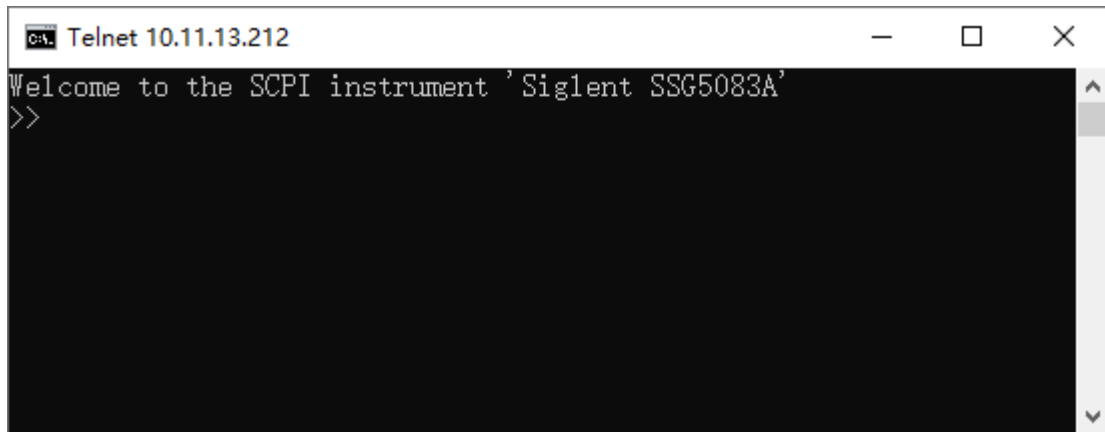

4. From the SCPI prompt:

- Type single SCPI commands. Press Enter to send the command.

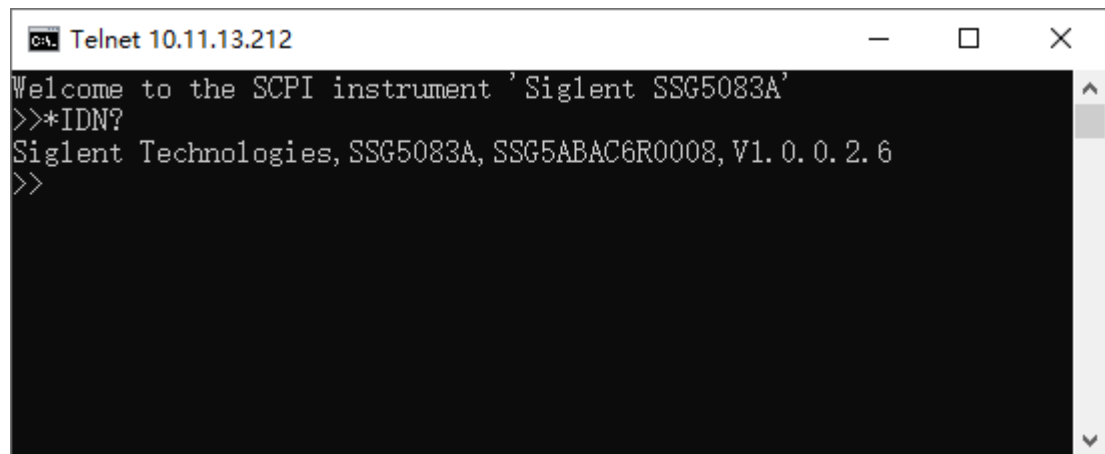

- To exit the telnet window click X in the upper-right corner.
- To get a normal telnet prompt, press Ctrl +] (closing bracket).

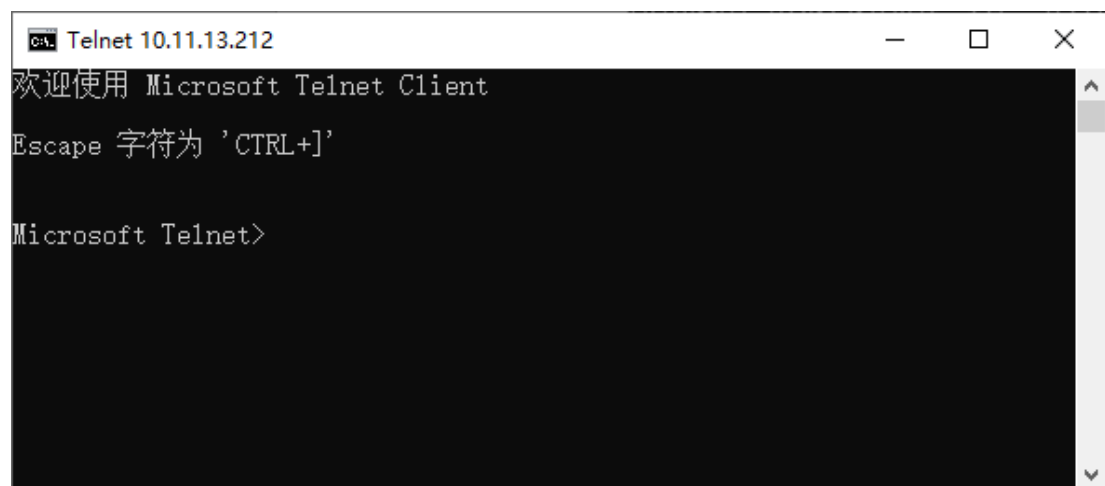

- To get SCPI prompt again, type open <ip Address> 5024 and press Enter:

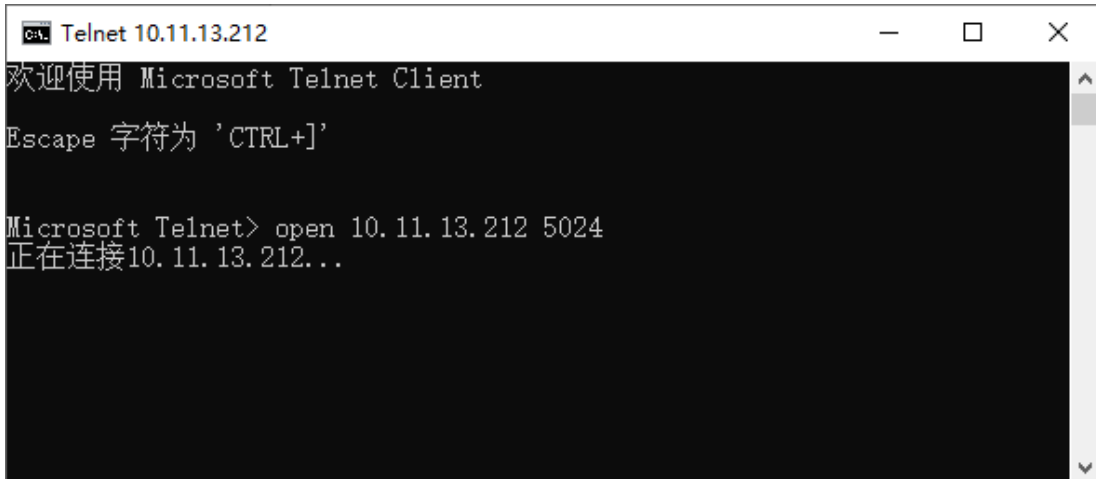

```

CAL Telnet 10.11.13.212
欢迎使用 Microsoft Telnet Client
Escape 字符为 'CTRL+]'

Microsoft Telnet> open 10.11.13.212 5024
正在连接10.11.13.212...
  
```

- To close the normal telnet window, type **Quit** and press **Enter**.

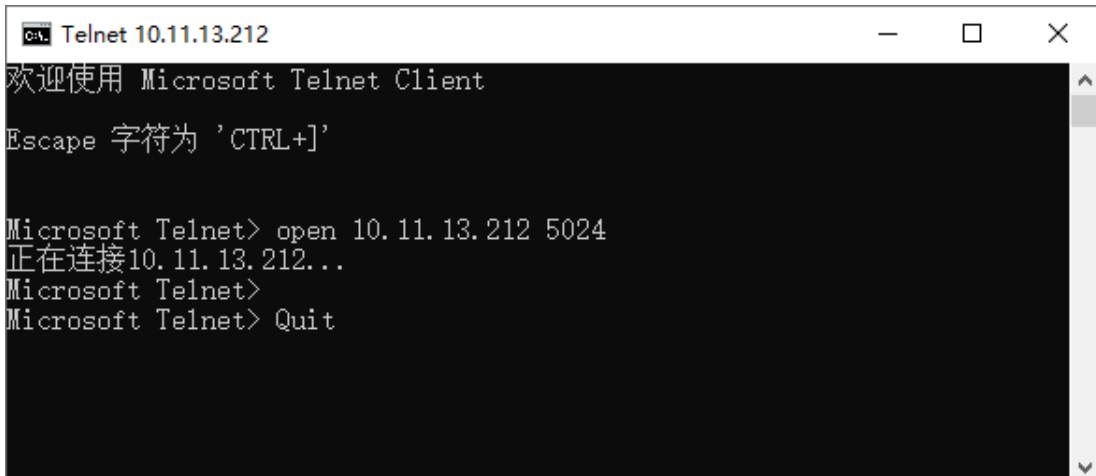

```

CAL Telnet 10.11.13.212
欢迎使用 Microsoft Telnet Client
Escape 字符为 'CTRL+]'

Microsoft Telnet> open 10.11.13.212 5024
正在连接10.11.13.212...
Microsoft Telnet>
Microsoft Telnet> Quit
  
```



About SIGLENT

SIGLENT is an international high-tech company, concentrating on R&D, sales, production and services of electronic test & measurement instruments.

SIGLENT first began developing digital oscilloscopes independently in 2002. After more than a decade of continuous development, SIGLENT has extended its product line to include digital oscilloscopes, isolated handheld oscilloscopes, function/arbitrary waveform generators, RF/MW signal generators, spectrum analyzers, vector network analyzers, digital multimeters, DC power supplies, electronic loads and other general purpose test instrumentation. Since its first oscilloscope was launched in 2005, SIGLENT has become the fastest growing manufacturer of digital oscilloscopes. We firmly believe that today SIGLENT is the best value in electronic test & measurement.

Headquarters:

SIGLENT Technologies Co., Ltd

Add: Bldg No.4 & No.5, Antongda Industrial Zone, 3rd Liuxian Road, Bao'an District, Shenzhen, 518101, China
Tel: + 86 755 3688 7876

Fax: + 86 755 3359 1582

Email: sales@siglent.com

Website: int.siglent.com

North America:

SIGLENT Technologies America, Inc

6557 Cochran Rd Solon, Ohio 44139

Tel: 440-398-5800

Toll Free: 877-515-5551

Fax: 440-399-1211

Email: info@siglentna.com

Website: www.siglentna.com

Europe:

SIGLENT Technologies Germany GmbH

Add: Staetzlinger Str. 70

86165 Augsburg, Germany

Tel: +49(0)-821-666 0 111 0

Fax: +49(0)-821-666 0 111 22

Email: info-eu@siglent.com

Website: www.siglenteu.com

Follow us on
Facebook: [SiglentTech](https://www.facebook.com/SiglentTech)

